

Isokern Standard 36" Fireplace

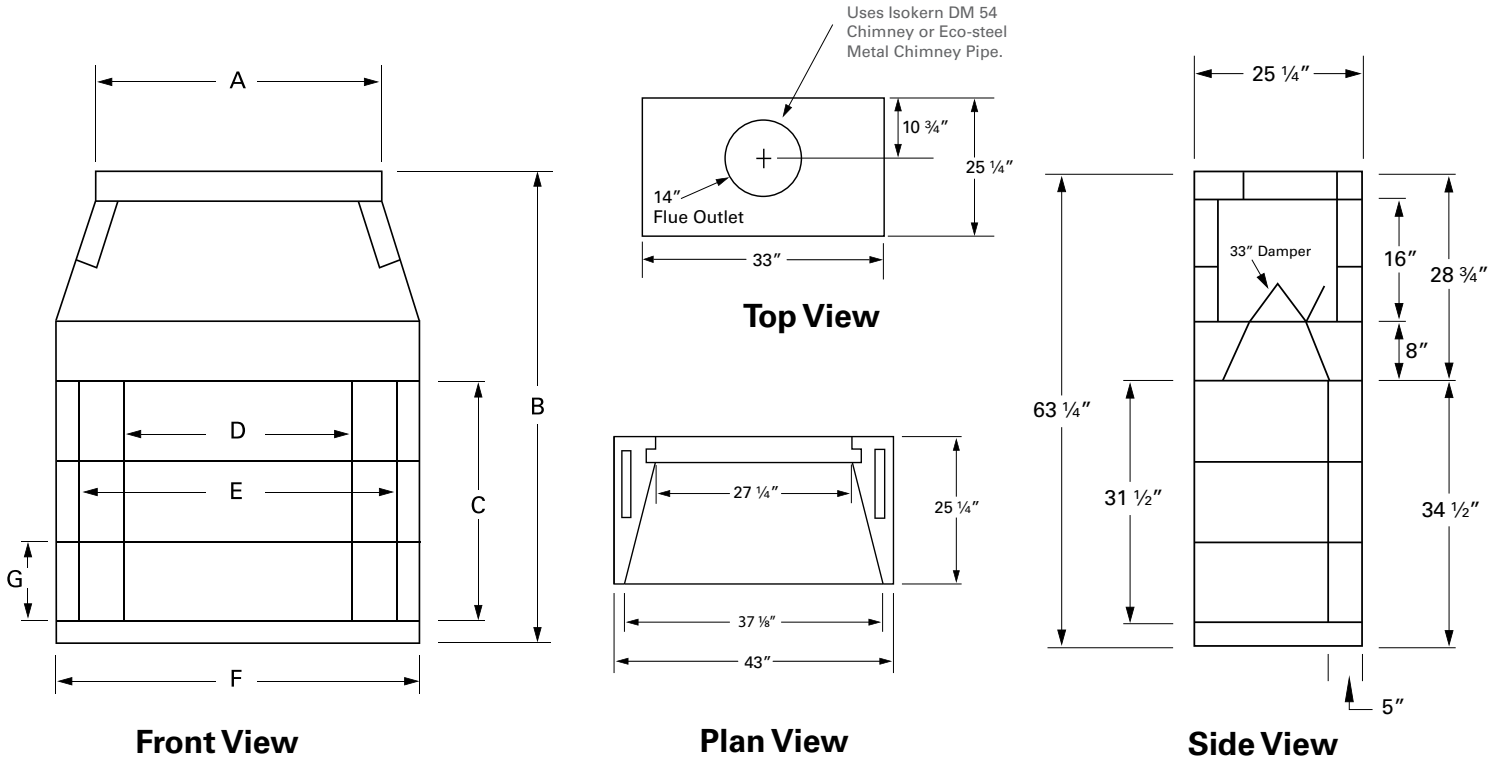

6899 Phillips Industrial Blvd. • Jacksonville, FL 32256

Project Name: _____ Location: _____



MINIMUM FRAMING DIMENSIONS

Framing dimensions maintain 1 1/2" clearance to combustibles. Refer to product manual for further installation instructions.

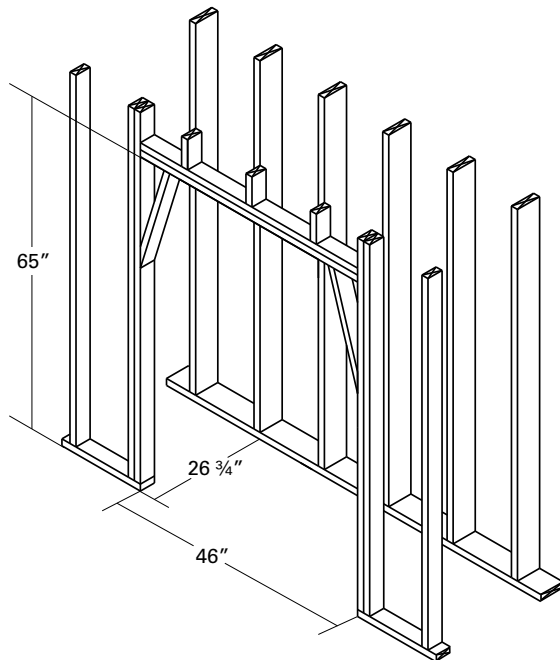

FIREPLACE OPTIONS

- Hearth Height: _____
- Brick Type: _____
- Brick Color: _____
- Brick Pattern: _____
- Damper: _____
- Chimney Type: _____
- Offset: _____
- Other Options: _____
- Spark Arrestor/Termination: _____
- Enervex RSHT Chimney Fan: _____
- Decorative Termination: _____
- Gas Log Set: _____
- Wood Grate: _____

Notes: _____

The total weight for the Standard 36" fireplace is approximately 1205 lbs. This dry weight includes fireplace pumice components only, additional weight from mortar, damper, firebrick and chimney not included.