

ISOFLAMES® STADIUM BURNER

Installation, Operation, Maintenance and Owner's Manual

ISOFLAMES STADIUM BURNER MODELS:

ISF24SB-SN ISF36SB-SN

ISF24SB-SP ISF36SB-SP

A PRODUCT OF EARTHCORE® INDUSTRIES, LLC

Important: This manual contains assembly rules, installation steps, guidelines, use and maintenance instructions for the ISOFLAMES STADIUM BURNER Series. This manual must become the property of and be reviewed by all current and future users of this product. It is the responsibility of the installer of this product to ensure that the instructions in this manual are followed exactly and that the burner be installed in strict accordance with the following sizing, installation, and operation instructions. It is the responsibility of the installer to provide adequate clearances as specified in this manual.

INSTALLER: Leave this manual with the appliance

CONSUMER: Retain this manual for future reference

Be Sure to Read Entire Manual Before Beginning Construction.

Contents of this manual may change without prior notification.



WARNING:

FIRE OR EXPLOSION HAZARD

Failure to follow safety warning exactly could result in serious injury, death, or property damage.

- Do not store or use gasoline or other flammable vapors and liquids in the vicinity of this or any other appliance.
- WHAT TO DO IF YOU SMELL GAS
 - Do not try to light any appliance.
 - Leave the building immediately.
 - Do not touch any electrical switch; do not use any phone in your building.
 - Immediately call your gas supplier from a neighbor's phone. Follow the gas supplier's instructions.
 - If you cannot reach your gas supplier, call the fire department.
- Installation and service must be performed by a qualified installer, service agency or the gas supplier.

- Design Certified to Z21.60 – 2017 Decorative Gas Appliance for installation in solid-fuel burning fireplace

The Isoflames Stadium Burner is to be installed in a solid-fuel burning fireplace with a working flue and constructed of noncombustible material. The installation including provisions for combustion and ventilation air must conform with the National Fuel Gas Code, ANSI Z223.1/NFPA 54, or the CSA B149.1 Natural Gas and Propane Installation Code, and applicable local building codes. Chimney damper must be fixed in a manner that will maintain the minimum permanent vent opening at all times. A damper clamp is supplied to maintain the minimum permanent vent opening and prevent complete closure of damper flap. **Warning:** Solid fuels shall not be burned in a fireplace where a decorative appliance is installed.



PFS Report No. F21-725.

Issued: March 2024

Revision: 001

©2024 Earthcore Industries, LLC

THESE APPLIANCES ARE DESIGNED for USE with: PROPANE (LP) or NATURAL GAS (NG), ONLY

THIS MANUAL CAN ONLY BE REPRODUCED IN ITS ENTIRETY

Table of Contents

Table of Contents	2
Isoflames Stadium Burner - Safety Instructions	3-5
Isoflames Stadium Burner – S Series Components List	6
Isoflames Stadium Burner - Specifications	7
Gas Line & Valve Box Installation	8
Valve Box & Burner Wiring Diagram	9
Burner Installation.....	10
Remote Control System	11
Burner Lighting Instructions.....	13
Burner Media and Log Installation	14-17
Troubleshooting	18
Registration Card.....	19
Warranty	20

SAFETY INSTRUCTIONS

WARNING!!! This appliance assembly contains burner orifices specifically for the input gas specified on the burner and box, as well as the BTU rating specified in this manual. Modifying or failure to use the factory orifice may cause property damage, personal injury, or loss of life.

Read these instructions completely before installing and using ISOFLAMES STADIUM BURNER.

1. Solid fuels shall not be burned with the ISOFLAMES STADIUM BURNER , or any fireplace where a decorative gas appliance has been installed.
2. The minimum inlet supply pressure for the purpose of input adjustment is 5.0 inches (natural gas) 11.0 inches (propane) in water column. The maximum inlet supply pressure is 10.5 inches (natural gas) 13.0 inches (propane) in water column.
3. Gas type will be indicated on the burner rating plate. Do not use a natural gas burner with propane or a propane burner with natural gas. Appliance is not convertible to use other gases.
4. The installation, provisions for combustion, and ventilation air must conform to the National Fuel Gas Code, ANSI Z223.1/ NFPA 54, or the Natural Gas and Propane Installation code, CSA B149.1.
5. The appliance and its main gas valve must be disconnected from the gas supply piping system during any pressure testing of that system at test pressures in excess of 1/2 psi (3.5 kPa). The appliance must be isolated from the gas piping system by closing its equipment shutoff valve during any pressure testing of the supply piping system at test pressures equal to or less than 1/2 psi (3.5 kPa).
6. Do not use this appliance if any part has been under water. Immediately call a qualified service technician to inspect the appliance and to replace any part of the control system and any gas control which has been under water.
7. Periodic examination and cleaning of the venting system of the solid fuel burning fireplace, including frequency of such examination and cleaning, by a qualified agency.
8. The appliance area is to be clear and free from combustible materials, gasoline and or flammable vapors and liquids. For warranty to be valid gas log sets must be installed by a NFI certified or other qualified professional installer.
9. Always check local building codes governing fireplaces and fireplace installations. ISOFLAMES STADIUM BURNER installation must comply with all local, regional, state, and national codes and regulations.
10. This appliance is only for use with the type of gas indicated on the rating plate. This appliance SHALL NOT be field converted for use with other gases with Propane (LP) or Natural Gas (NG).
11. This appliance shall only be installed, serviced, or inspected by qualified professional service technician.
12. For propane (LP) use do not place propane supply tank(s) inside any structure. Locate propane supply tank(s) outdoors.
13. To prevent performance problems, do not use propane fuel tank of less than 100 lbs. capacity.
14. This decorative gas appliance reaches high temperature. Keep children and adults away from hot surfaces to avoid burns or clothing ignition. Fireplace will remain hot for a time after shutdown. Allow surfaces to cool before touching.
15. Turn the appliance off and allow to cool before servicing. Always shut off any electricity and gas to the appliance while working on it. Only a qualified service person should install, service or repair this appliance. Have your appliance inspected annually by a qualified service person.

SAFETY INSTRUCTIONS

16. It is imperative that the unit's control areas, burners and circulation air passages be kept clean.
17. Keep all combustible material, gasoline, and other flammable liquids at a safe distance from the fireplace. Do not use the appliance where these items are used or stored. Decorations, clothing, and other such combustible items should not be placed on the appliance.
18. Do not cook food or burn paper or other object(s).
19. Do not use any solid fuels - wood, coal, paper, cardboard, etc. - Use only the gas type listed on the fireplace's burner rating plate.
20. Do not in any way obstruct the flow of combustion and ventilation air. Provide adequate clearances around air openings into the combustion chamber as well as adequate accessibility clearances for servicing and proper operation.
21. Never install an ISOFLAMES STADIUM BURNER component or accessory that has visible or suspected physical damage. These items should be inspected by a qualified representative to ensure safe condition. When in doubt, consult your local supplier.
22. Do not alter or modify the ISOFLAMES STADIUM BURNER or burner components under any circumstances. Modification or alteration of any sort may void manufacturer's warranty, listings, and approvals.
23. The ISOFLAMES Stadium Burner system is not intended to heat an entire home or to be used as a primary heat source.
24. Children and adults should be alerted to the hazards of high surface temperature and should stay away from this appliance to avoid burns or clothing ignition.
25. Young children should be carefully supervised when they are in the same room as the appliance. Toddlers, young children, and others may be susceptible to accidental contact burns. A physical barrier is recommended if there are at-risk individuals in the house. To restrict access to the fireplace, install an adjustable safety gate to keep toddlers, young children, and other at-risk individuals out of the room and away from hot surfaces.
26. Clothing or flammable material should not be placed on or near the appliance.
27. Due to high temperatures, the appliance should be located out of traffic and away from furniture and draperies.
28. Any safety screen, guard, or barrier removed for servicing an appliance must be replaced prior to operating the appliance.
29. Installation and repair should be done by a qualified service person. The appliance should be inspected before use and at least annually by a professional service person. More frequent cleaning may be required due to excessive lint from carpeting, bedding material, etcetera. It is imperative that control compartments, burners, and circulating air passageways of the appliance be kept clean.

SAFETY INSTRUCTIONS

WARNING!!!: This product contains or generates chemicals known to the state of California to cause cancer or birth defects or other reproductive harm.

IMPORTANT: Read this owner’s manual carefully and completely before trying to assemble, operate or service this fireplace. Improper use of this fireplace can cause serious injury or death from fire, burns, explosions, and carbon monoxide poisoning.

DANGER!!!: CARBON MONOXIDE POISONING MAY LEAD TO DEATH!

Propane (LP) gas and natural gas (NG) are both colorless and odorless gases. An odor making agent is added to each of these gases to help you detect a gas leak. However, the odor added to these gases can fade and gas may be present even though no odor exists.

Carbon Monoxide Poisoning: Early signs of carbon monoxide poisoning resemble flu symptoms, including headaches, dizziness or nausea. If you have these signs the fireplace may not have been installed properly, get fresh air at once! Have the fireplace inspected and serviced by a qualified service person or your gas supplier. Some people are more affected by carbon monoxide than others. These include pregnant women, people with heart or lung diseases or anemia, people at high altitude or under the influence of alcohol. Earthcore Industries strongly recommends the use of a carbon monoxide detector/alarm device wherever gas fired appliances are in use.

All parties either involved in or associated with the installation, service and use of this fireplace must read this entire manual. Keep this manual for reference and as a guidebook to safe operation of this fireplace.

WARNING!!!: Vented decorative gas appliance: not a source of heat; not for use with solid fuel

ANSI Z21.60 RATING PLATE

NATURAL GAS PLATE

L.P. (PROPANE) PLATE



MADE IN THE USA
CHESAPEAKE, VA 23323

ISOFLAMES STADIUM BURNER

NOT FOR USE WITH SOLID FUEL

SERIAL NO: SBN000001



PFS REPORT NO. F21-725

GAS TYPE: NATURAL GAS
MANIFOLD PRESSURE: 3.5" - 1.6" WC
MINIMUM INLET GAS SUPPLY PRESSURE: 5" WC
MAXIMUM INLET GAS SUPPLY PRESSURE: 10.5 WC

VARIABLE FLAME MODEL

ISF245B-SN MAX BTU 62,000; MIN BTU 44,000
 ISF365B-SN MAX BTU 85,000; MIN BTU 51,000

ANSI Z21.60-2017 - CSA 2.26-2017, Decorative Gas Appliances for Installation in Solid-Fuel Burning Fireplaces

WARNING: For installation in a solid-fuel burning fireplace only. The fireplace chimney must have a permanent vent opening to atmosphere of not less than (see table) square inches and a minimum chimney height of 15'

MINIMUM FIREPLACE DIMENSIONS (in):

MODEL	DEPTH	HEIGHT	REAR WIDTH	FRONT WIDTH	CHIMNEY OPENING (in ²)
24	18	20	25	34	39
36	18	20	36	44	51

EARTHCORE INDUSTRIES HEADQUARTERS - 6899 PHILLIPS INDUSTRIAL BLVD JACKSONVILLE, FL 32256



MADE IN THE USA
CHESAPEAKE, VA 23323

ISOFLAMES STADIUM BURNER

NOT FOR USE WITH SOLID FUEL

SERIAL NO: SBP000001



PFS REPORT NO. F21-725

GAS TYPE: PROPANE
MANIFOLD PRESSURE: 10" - 6.4" WC
MINIMUM INLET GAS SUPPLY PRESSURE: 11" WC
MAXIMUM INLET GAS SUPPLY PRESSURE: 14 WC

VARIABLE FLAME MODEL

ISF245B-SP MAX BTU 56,000; MIN BTU 44,000
 ISF365B-SP MAX BTU 81,000; MIN BTU 61,000

ANSI Z21.60-2017 - CSA 2.26-2017, Decorative Gas Appliances for Installation in Solid-Fuel Burning Fireplaces

WARNING: For installation in a solid-fuel burning fireplace only. The fireplace chimney must have a permanent vent opening to atmosphere of not less than (see table) square inches and a minimum chimney height of 15'

MINIMUM FIREPLACE DIMENSIONS (in):

MODEL	DEPTH	HEIGHT	REAR WIDTH	FRONT WIDTH	CHIMNEY OPENING (in ²)
24	18	20	25	34	36
36	18	20	36	44	49

EARTHCORE INDUSTRIES HEADQUARTERS - 6899 PHILLIPS INDUSTRIAL BLVD JACKSONVILLE, FL 32256

The latest revision of this installation manual is available on the Earthcore website:



SCAN

COMPONENT LIST

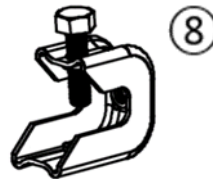
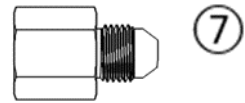
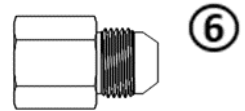
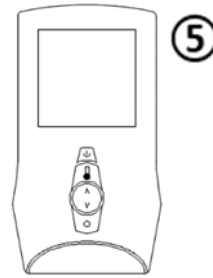
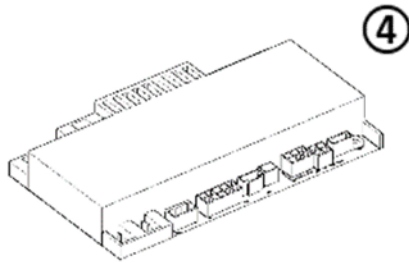
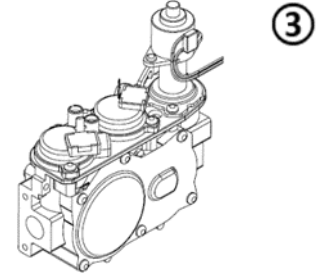
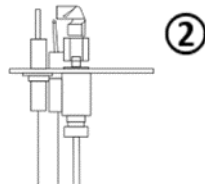
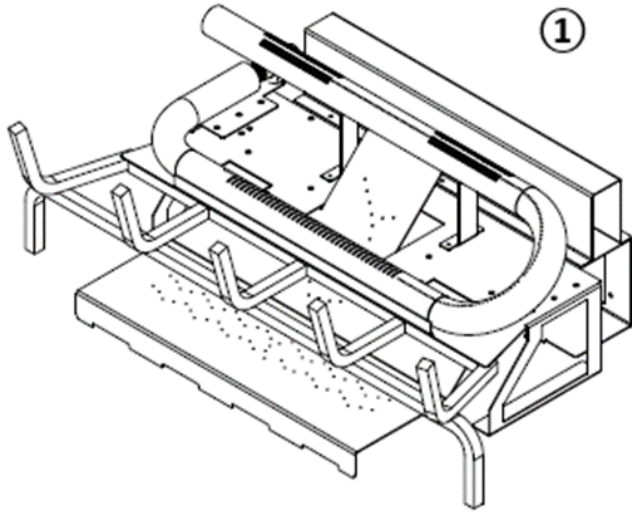

Item No.	Description	Part No.	Qty
1	Main Burner Assembly (natural gas)	ISF24SB-SN, ISF36SB-SN	1
	Main Burner Assembly (propane)	ISF24SB-SP, ISF36SB-SP	1
2	Pilot Assembly (natural gas)	ISF-E-PAN	1
	Pilot Assembly (propane)	ISF-E-PAP	1
3	Gas Valve (natural gas)	ISF-E-GVN	1
	Gas Valve (propane)	ISF-E-GVP	1
4	Control module/remote receiver	ISF-E-ICM	1
5	Remote Transmitter	ISF-E-RM	1
6	1/2" Male Flare to 3/8" NPT Female Adapter	E-12FF-38FIP	1
7	3/8" Male Flare to 3/8" NPT Female Adapter	E-38FF-38FIP	1
8	Damper Clamp	ISF-E-DC	1

Isoflames Stadium Burner - Specifications

TABLE 2

Variable Flame Models Burner Specifications								
Burner Model	Minimum Fireplace Dimension (in)				BTU			
	Depth	Height	Width		Nat. Gas		L.P. Gas	
			Front	Rear	High	Low	High	Low
ISF24SB	18	20	34	25	62K	44K	56K	44K
ISF36SB	18	20	44	36	85K	51K	81K	61K

NOTE: Opening height is measured from hearth floor to bottom of lintel

TABLE 3

Minimum Venting Requirements		
Chimney Height (ft)	Minimum Permanent Free Opening of Chimney Damper (sq. in) Factory-Built Fireplace	
	ISF24SB	ISF36SB
15	25.3	41.9
20	23.1	34.2
25	19.5	29.2
30	18.0	26.4
	Masonry-Built Fireplace	
15	42.9	37.5
20	35.3	34.1
30	32.0	30.9

Note: Height is measured from bottom of lintel to top of chimney and minimum height is 15 ft.

GAS LINE & VALVE BOX INSTALLATION

This appliance must be connected to the gas line in accordance with local codes and/or the National Fuel Gas Code, ANSI Z223.1. After connecting the gas line, all joints in the line and connections at the valve should be checked for leaks before final positioning of the unit. Conduct a gas leakage test of the appliance piping and control system downstream of the shutoff valve in the supply line to the appliance.

1. The valve control box comes with a 110" pilot assembly lead; therefore, the box must be mounted within 7' of the fireplace. (Figure 1)
2. Attach the metal enclosure to the studs using standard building materials. The metal enclosure must be mounted in a location that can be accessed in the future for additional connections & future servicing.
3. Installation and servicing of gas appliances and ignition systems must only be performed by qualified personnel.
4. Turn off gas and electricity before starting installation or service.
5. Make sure gas valve is rated for gas being used.
6. Make sure gas piping is pressure tested before control is connected. High pressure can damage the control causing a hazardous condition.
7. Make sure piping is clean and free from burrs. Apply a small amount of good quality gas-rated pipe thread compound or plumbers' tape suitable for the gas being used. Thread compound should be used sparingly on male threads only, leaving the first two threads clean.
8. Inlet and Outlet of valve are $\frac{3}{8}$ " NPT.
9. It is recommended that a safety shut off valve is installed on the gas inlet side of the valve.
10. It is recommended to hard pipe in the connections with unions installed inside the box.
11. Gas outlet from the valve should terminate into the firebox and project no less than 2" from firebrick wall

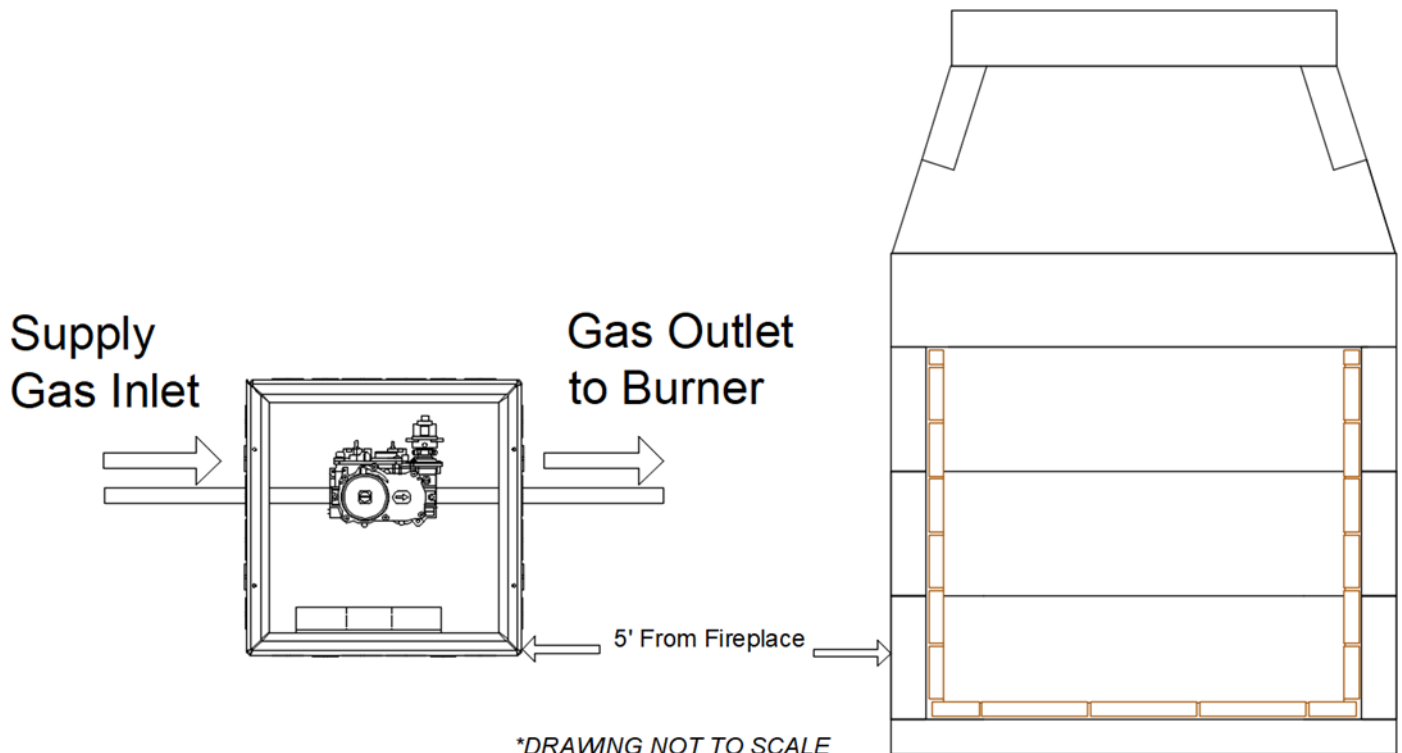

FIGURE 1

VALVE BOX & BURNER WIRING DIAGRAM

WARNING!!!: Do not connect 120 VAC to the control valve.

The appliance and its appliance main gas valve must be disconnected from the gas supply piping system during any pressure testing of that system at test pressures in excess of 1/2 psi (3.5 kPa).

The appliance, when installed, must be electrically grounded in accordance with local codes or in the absence of local codes, with the National Electrical Code, ANSI/NFPA 70. If not installed and maintained in accordance with the manufacturer’s instructions, this product could expose you to substances in fuel or fuel combustion which are known to the state of California to cause cancer, birth defects or other reproductive harm.

For a copy of the homeowner’s care and operation manual, go to www.earthcore.com or call 1-800-642-2920.

FIGURE 1

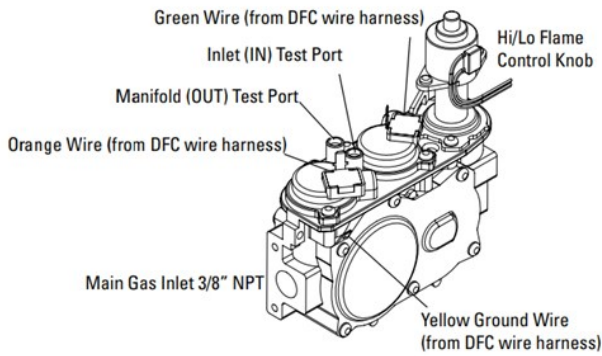

TABLE 1

FUEL TYPE	INLET PRESSURE			MANIFOLD PRESSURE	
	DESIRED	MINIMUM	MAXIMUM	HIGH FLAME	LOW FLAME
NATURAL GAS	7" WC	5" WC	10.5" WC	3.5" WC	1.6" WC
LP GAS	11" WC	10.5 WC	13" WC	10" WC	6.4" WC

Schematic Representation Only

COLOR CODE :

- B = BLACK
- BB = BROWN W/BLACK STRIPE
- BR = BROWN
- G = GREEN
- GY = GRAY
- Y = YELLOW
- W = WHITE

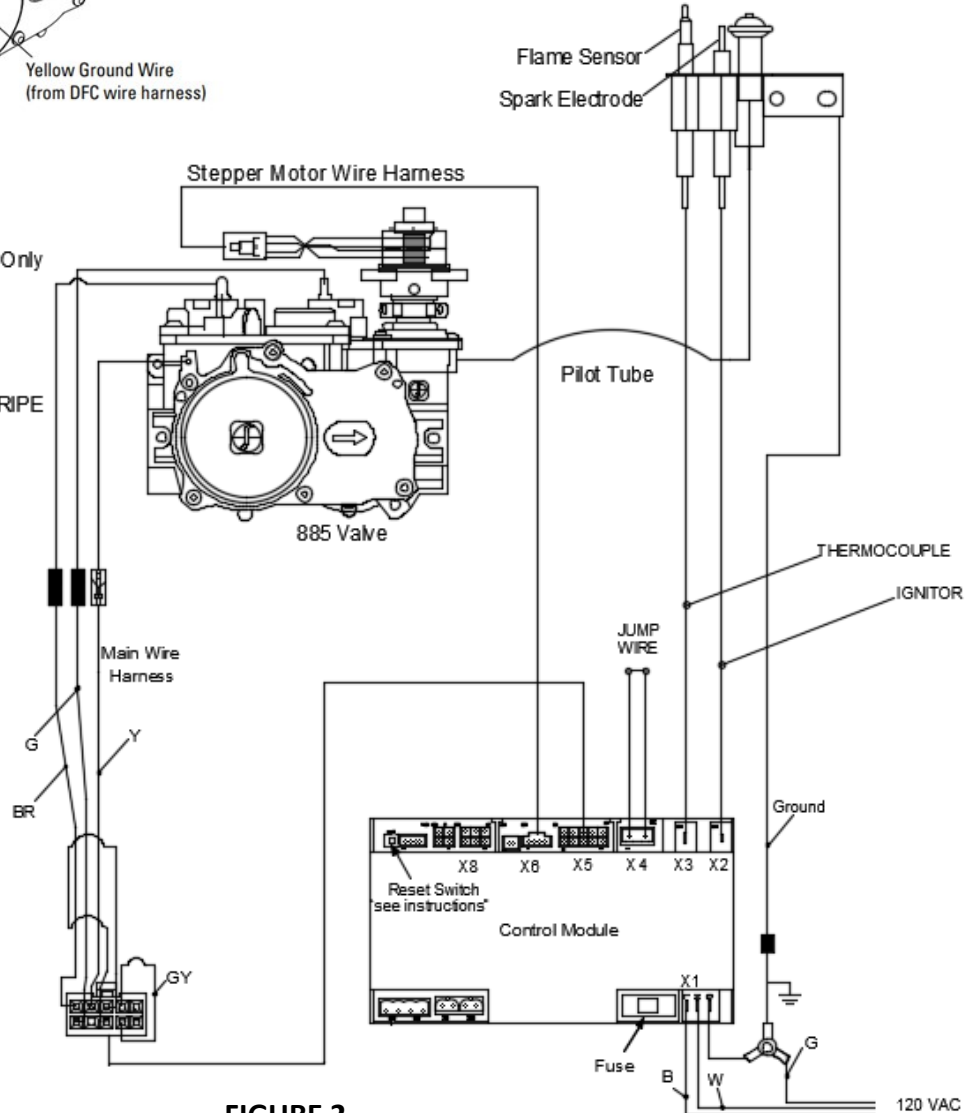

FIGURE 2

BURNER INSTALLATION

IMPORTANT: Prior to installation: Shut off main gas supply to fireplace.

The ISOFLAMES STADIUM BURNER shall be installed by qualified professional service technician. To ensure proper performance of the appliance the owner's installation manual must be followed carefully.

1. Position the burner in the center of fireplace floor towards the rear. Leave a minimum 1" clearance from the rear wall.
2. Uncoil the pilot assembly. Be careful to not create unwanted kinks in the pilot tubing.
3. Feed the pilot assembly through the bottom of the burner cut out and mount the bracket using the provided screws/nuts. Figure 5 & 6
4. Feed the pilot assembly connectors through the hole of the sidewall towards the valve box, be careful not to clog the flared fitting of the pilot tube or damage the spade connectors.
5. Plug the spade connectors into the module according to the wiring diagram (Figures 4, 5 & 7), insert the pilot tubing into the right side of the valve and, using a wrench, tighten the nut so that the pilot tubing cannot be pulled out.
6. Ensure the appropriate flared fitting is connected to the gas supply stub.
7. Connect the open end of 12" flex connector to the gas-supply. Figure 8
8. Avoid creating kinks in the flex connector.
9. Install the jumper wire on Terminal X4 on the control module. Once X4 is jumpered, the REMOTE transmitter functions as a burner and pilot override switch.
10. Make sure all connections are tightly secured.
11. Spread media evenly across burner pan section. Page 15
12. Proceed to burner lighting instructions.

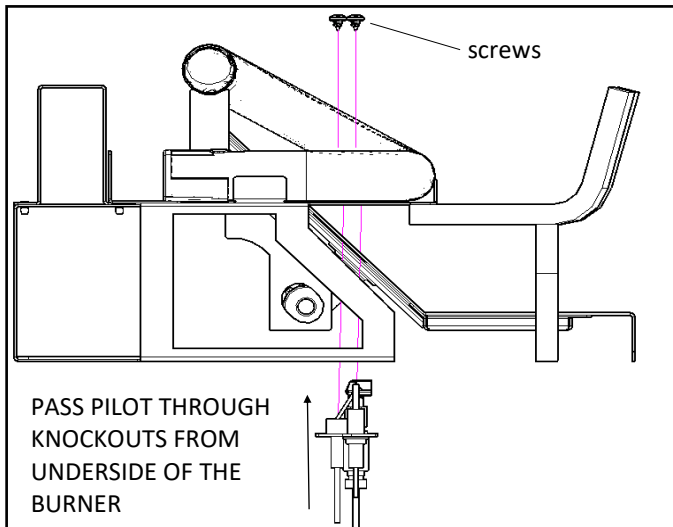
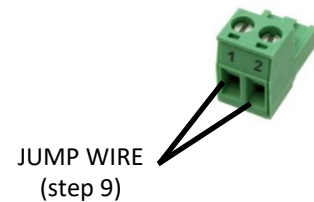

FIGURE 5

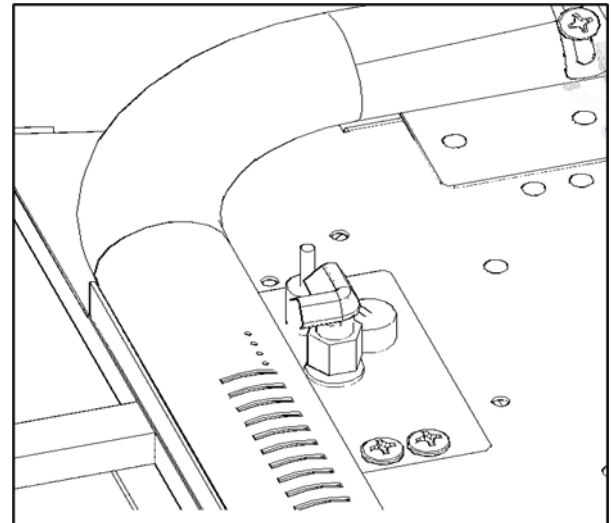

FIGURE 6

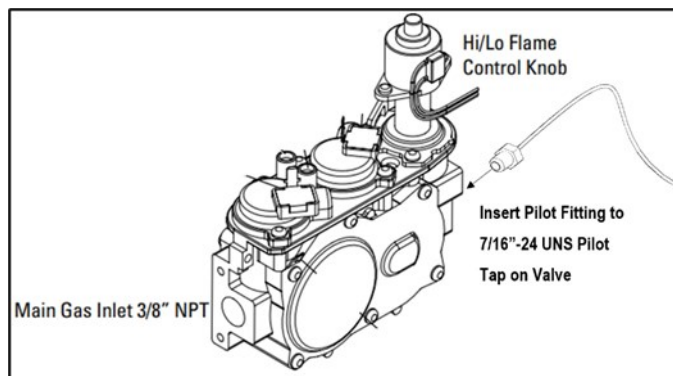

FIGURE 7

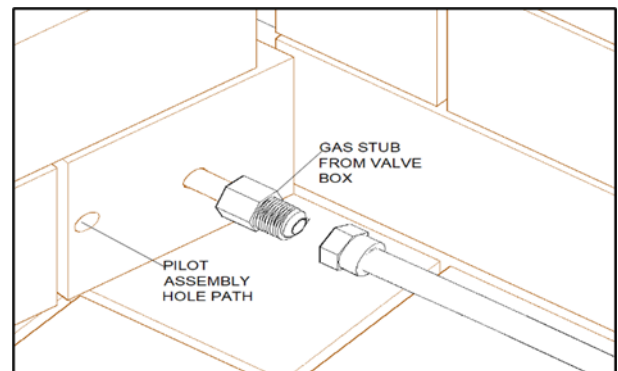

FIGURE 8

REMOTE CONTROL SYSTEM

The Remote allows you to command the functions of your appliance from the comfort of your chair and is configured to control the On/Off primary burner operation, its flame height through six (6) levels, and provides On/Off control of the appliance.

SYNCHRONIZE REMOTE TO CONTROL MODULE FOR THE FIRST TIME

1. Insert the three (3) provided AAA batteries into the battery bay in the remote. Correctly align polarity (+/-).
2. Press the red SW1 button on the control module. The control module will beep 3 times and an amber LED is illuminated to indicate that the control module is ready to synchronize with a remote within 10 seconds.
3. Push the "ON" button on the remote (**Figure 9**). The control module will beep four (4) times to indicate acceptance of the remote's command. The system is now synchronized.

TURN ON THE APPLIANCE

Press the ON/OFF Key on the Remote. The Remote LCD display will only show all active Icons on the screen and the appliance burner will turn on. A single "beep" from the module confirms reception of the command.

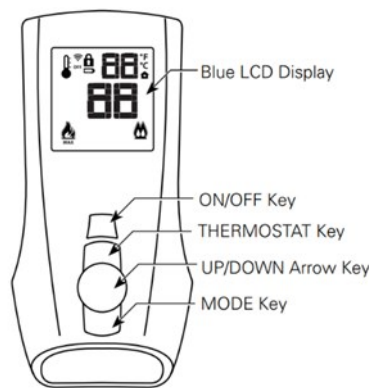

FIGURE 9

REMOTE FLAME CONTROL

The system has six (6) flame levels. See (**Figure 10**) for an example. With the system on, and the flame level at the maximum in the appliance, pressing the Down Arrow Key once will reduce the flame height by one step until the flame is turned off. The Up-Arrow Key will increase the flame height each time it is pressed. If the Up Arrow Key is pressed while the system is on, but the flame is off, the flame will come on in the high position (**Figure 10**). A single "beep" will confirm reception of the command.

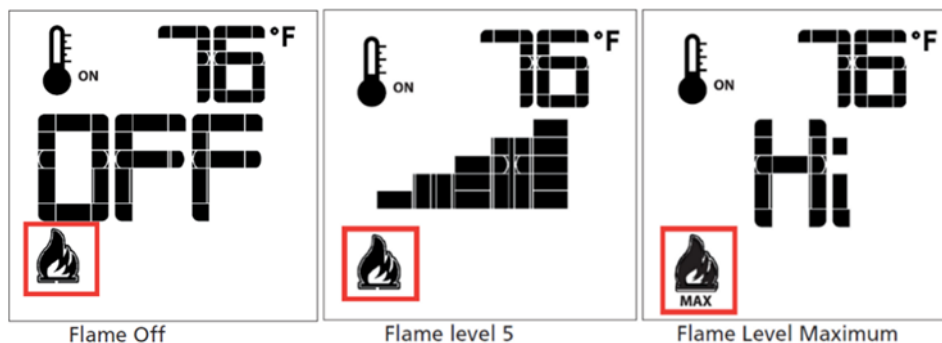

FIGURE 10

REMOTE CONTROL SYSTEM

TEMPERATURE INDICATOR DISPLAY

With the system in the “OFF” position, press the Thermostat Key and the Mode Key at the same time (Figure 9). Look at the LCD screen on the Remote to verify that a C or F is visible to the right of the Room Temperature display (Figure 11).



FIGURE 11

TURN OFF THE APPLIANCE

Press the ON/OFF Key on the Remote. The Remote LCD display will only show the room temperature and the appliance will turn off. A single “beep” from the module confirms reception of the command.

FLAME COLOR AND BEHAVIOR

This appliance is designed for maximum heating efficiency. Therefore, upon lighting of the main burner, the flames will be semi-transparent or “bluish.” After 10-20 minutes of operation, the logs will heat up and the flames will become a yellow/orange color.

Adjusting the appliance to cause the flames to turn orange sooner may result in poor combustion, sooting and a hazardous situation. See (Figure 12) showing proper flame appearance.

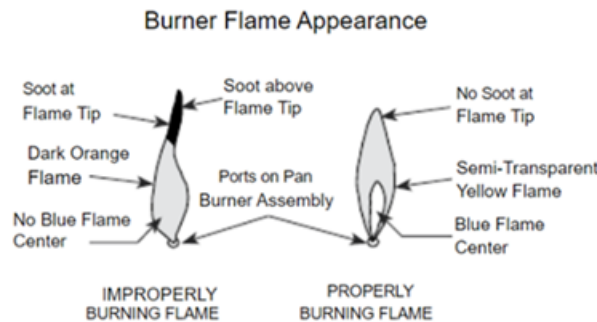

FIGURE 12

Continuous Pilot (CPI) & Intermittent Pilot (IPI) selection

The default setting is set to IPI. With the system in OFF position press the Mode Key (Figure 9) to index to the CPI mode icon. Pressing the UP Arrow Key will return to IPI. A single “beep” will confirm the reception of the command (Figure 13).

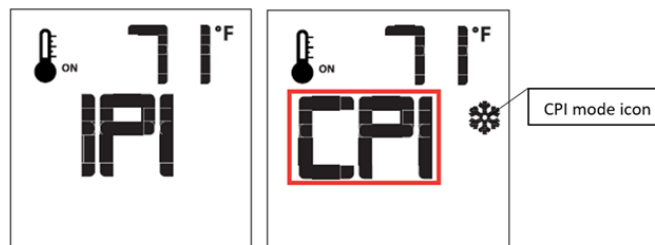

FIGURE 13

WARNING!!!: Fire hazard. Can cause severe injury or death. The receiver causes ignition of the appliance. The appliance can turn on suddenly. Keep away from the appliance burner when operating the remote system or activating manual bypass of the remote system.

WARNING!!!: Property damage hazard. Excessive heat can cause property damage. The appliance can stay lit for many hours. Turn off the appliance if it is not going to be attended for any length of time. Always place the Transmitter where children cannot reach it.

BURNER LIGHTING INSTRUCTIONS

INSTALLER INSTRUCTIONS

It is required that the set of safety instruction labels that have been supplied with the appliance be affixed to the operation and control points of the appliance. It is the installers responsibility to ensure these warnings are properly affixed during installation. These warning labels are a critical step in informing consumers of safe operation of this appliance.

PRE-LIGHTING CHECKLIST

Be sure to check these items before the initial lighting of the appliance:

- Gas pressure has been checked carefully.
- All gas fittings have been checked for leaks.
- All clearances to combustibles have been met.
- All combustibles materials have been removed from the area in front of the appliance.
- All vented areas of the appliance face are unobstructed.
- House is ventilated to clear initial paint curing odors.
- All packaging materials have been removed from the appliance.
- While appliance is cool, fingerprints or other marks have been cleaned from any plated surfaces with denatured alcohol and a soft cloth. Marks left on these surfaces may become permanent into the finish if not removed prior burning the unit.

WARNING!!!: IF YOU DO NOT FOLLOW THESE INSTRUCTIONS EXACTLY, A FIRE OR EXPLOSION MAY RESULT CAUSING PROPERTY DAMAGE, PERSONAL INJURY OR LOSS OF LIFE.

SAFETY INSTRUCTIONS

- A. This appliance is equipped with an ignition device which automatically lights the pilot. Do NOT try to light the pilot by hand.
- B. BEFORE OPERATING smell all around the appliance area for gas. Be sure to smell next to the floor because some gas is heavier than air and will settle on the floor.
- **WHAT TO DO IF YOU SMELL GAS:**
 - **Do not try to light any appliance.**
 - **Do not touch any electric switch; do not use any phone in your building.**
 - **Immediately call your gas supplier from a neighbor's phone. Follow the gas supplier's instructions.**
 - **If you cannot reach your gas supplier, call the fire department.**
- C. If any portion of this appliance does not operate as the instructions indicate, do not try to repair it, call a qualified service technician. Do not use tools. Force or attempted repair may result in a fire or explosion.
- D. **Do not use this appliance if any part has been under water.** Immediately call a qualified service technician to inspect the appliance and to replace any part of the system and any gas control which has been under water.

Main Power and Remote Overview

The jumper wire needs to be installed on Terminal X4 on the control module. Once X4 is jumpered, the REMOTE functions as a burner and pilot override switch

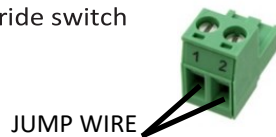

Remote Lighting Instructions

Press ON/OFF on Remote transmitter. Module will beep one time to confirm. Pilot will begin to spark. It may take several minutes for air to purge from pilot tube. Once pilot is ignited, the main burner will turn on.

TO TURN OFF GAS TO APPLIANCE

1. Press the "ON/OFF" key on remote to turn off appliance operation.
2. Turn off all electric power to the appliance if service is to be performed.
3. Close the main line gas shut-off valve.

BURNER MEDIA AND LOG INSTALLATION

1. Spread lava rock on the hearth floor of the fireplace around the front and sides of burner.
 - a. **DO NOT put lava rock directly on the burner OR behind it.**
2. Place embers along the pan section of the burner and spread evenly. **Figure 15**
 - a. It may be necessary to break large clumps into smaller pieces
 - b. For LP models, vermiculite media must be used prior to using embers.
3. Install Log Set according to Log Set instructions included with the log set package.

IMPORTANT: Read all safety warnings and ensure proper placement for safer operation.

IMPORTANT: DO NOT add additional logs or embers to this log set as it may cause unsafe operation.

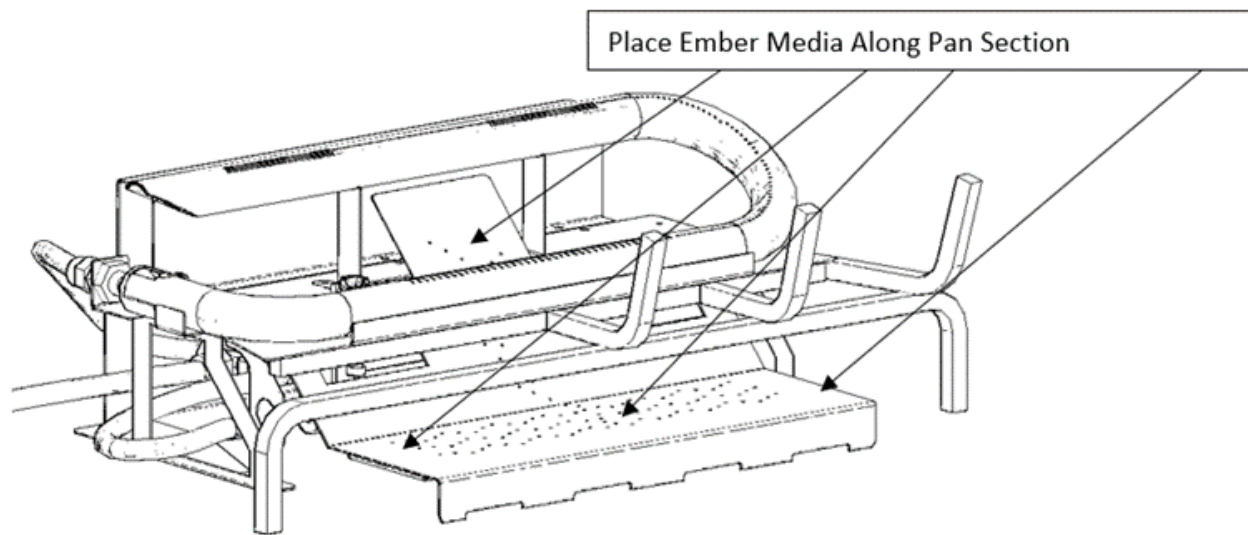

*Vermiculite must be used on LP burner models

FIGURE 15

NOTE: Burning Gas Logs for any length of time will create soot; generally, on the logs and firebrick. Soot is the result of incomplete combustion of the gas, producing dark dense material. Improper placement of the log set will contribute to excessive soot. It is critical to place logs according to the log placement diagrams. To clean off soot use an old toothbrush and gently rub away the soot. Periodic examination and cleaning of the venting system and the fireplace, including frequency of such examination and cleaning, by a qualified agency is recommended.

WARNING!!!: OPERATION OF THIS APPLIANCE WHEN NOT CONNECTED TO A PROPERLY INSTALLED AND MAINTAINED VENTING SYSTEM CAN RESULT IN CARBON MONOXIDE (CO) POISONING AND POSSIBLE DEATH.

BURNER MEDIA AND LOG INSTALLATION

24" Weathered Oak Logs

①

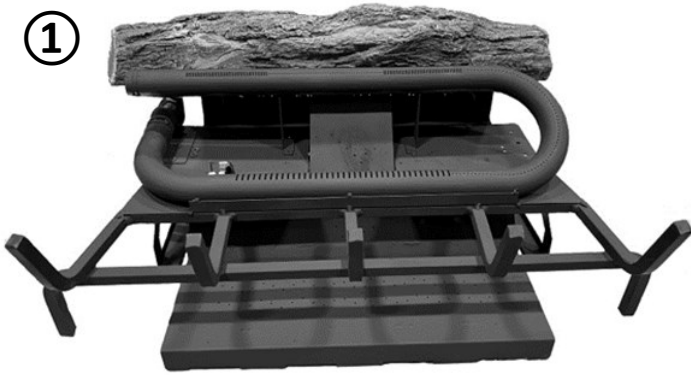

②



③



④



36" Weathered Oak Logs

①



②



③



④



BURNER MEDIA AND LOG INSTALLATION

24" Birch Logs

①



②



③



36" Weathered Oak Logs

①



②



③



④



TROUBLESHOOTING

Earthcore Industries Technical Support: 1-800-642-2920

Issue	Probable Cause	Possible Solution
No spark on pilot	No power	Verify power is ON Check wiring on ignition module and gas valve are correct
	Ignitor misalignment	Verify ignitor not contacting pilot gas hood
	Loose pilot connections	- Check pilot wiring assembly is tightly secured to ignition module
Pilot won't ignite	No spark	- See "No spark on pilot"
	Air in pilot gas line	- It may take a few minutes to purge out all the air from the pilot gas tube to ignite
	No gas	Verify pilot gas tube is threaded sufficiently to gas valve Verify all gas connections going to and from gas valve are tight Verify main gas-shutoff valve is in ON position
Pilot won't stay ignited	Flame sensor obstruction	- Remove any obstruction near pilot igniter and flame sensor
	Loose pilot connections	- Check pilot wiring assembly is tightly secured to ignition module
	Low gas pressure	- Verify adequate gas supply pressure
Remote won't work/unresponsive	Range	- Remote is too far from receiver
	Batteries need replacement	- Replace batteries on remote transmitter
	Program remote to receiver	- Sync remote transmitter to ignition module; Page 11
Main burner won't ignite	Pilot won't ignite	- See "Pilot won't ignite"
	Pilot flame won't stay ignited	- See "Pilot won't stay ignited"
	Defective valve/ignition module	- Replace gas valve or ignition module

REGISTRATION CARD

Please tear out along line and send to:

Earthcore Industries
Attn: Technical Department
6899 Phillips Industrial Blvd
Jacksonville, FL 32256

Dealer _____

Date of Purchase: _____

Date Of Installation: _____

Address: _____

City, State, Zip: _____

Phone No.: _____

Burner Model (Circle One):

ISF24SB

ISF36SB

Fuel Type (Circle One):

Natural Gas

Propane

Firebox Serial Number:

(Located on Rating Plate Inside Firebox) _____

Buyer: _____

Address: _____

City, State, Zip: _____

Phone No.: _____

Installed By: _____

Address: _____

City, State, Zip: _____

Phone No.: _____

WARRANTY

THIS WARRANTY DOES NOT COVER DRAFTING, SMOKING OR PUFFING OF THE FIREPLACE SYSTEM. Factors beyond the manufacturer's control affect fireplace drafting, smoking, and puffing, and EARTHCORE cannot guarantee these aspects of performance.

Burner – The ISOFLAMES STADIUM burner has a one-year warranty against any performance defects.

Gas Logs – The ISOFLAMES STADIUM gas logs have a one-year warranty against breakage, except breakage due to mishandling or negligence.

Control Valve – If the ISOFLAMES STADIUM burner was purchased with a gas control valve, the gas control valve has a one-year warranty against any performance defects.

Gas Logs – All painted surfaces that get wet due to rain, flooding, household pets, wild animals or birds, or get damaged due to negligence or disaster, have no warranty.

Accessories – Embers and lava coal that get wet due to rain, flooding, household pets, wild animals or birds, or get damaged due to negligence or disaster, have no warranty.

Parts not otherwise listed carry a 90-day warranty from the date of installation.

If a component is found to be defective under the terms of this warranty the party to whom this warranty is extended shall, notify Earthcore, 6899 Phillips Industrial Blvd, Jacksonville, Florida 32256, in writing, by registered mail, within thirty (30) days following the discovery of the defect within the lifetime warranty period. The notice shall contain (1) the date of purchase; (2) place of purchase; (3) address of installation; (4) name, address and phone number of the owner; and (5) a brief description of the defect.

Earthcore, or any division thereof, is not responsible for any labor costs or indirect costs incurred for the replacement of defective components.

Earthcore is not responsible for misuse or mishandling of components. Nothing in this warranty makes Earthcore, or any division thereof, liable in any respect for any injury or damage to the building or structure in which the fireplace or chimney system has been installed or to persons or property therein arising out of the use, misuse, or installation of properly manufactured Earthcore product.

EARTHCORE, OR ANY DIVISION THERE OF, SHALL NOT BE HELD LIABLE FOR ANY INCIDENTAL OR CONSEQUENTIAL DAMAGES OR EXPENSES ARISING OUT OF THE USE OF THE FIREPLACES OR CHIMNEY SYSTEMS. ALL SUCH DAMAGES AND EXPENSES ARE HEREBY EXCLUDED.

This warranty is null and void when the fireplace or chimney systems are not installed pursuant to the installation instructions provided by Earthcore or local building codes have not been followed completely.

This warranty applies only to those fireplace and chimney systems installed in the continental United States and Canada. If any part of this warranty is found to be unenforceable, the remaining parts shall remain in force and effect.

EARTHCORE HEREBY DISCLAIMS ALL GUARANTEES AND WARRANTIES, EXPRESS OR IMPLIED, BEYOND THE WARRANTIES SET FORTH HEREIN.

earthcore[®]

6899 Phillips Industrial Blvd. • Jacksonville, FL 32256 • 904.363.3417 • f: 904.363.3408 • earthcore.com