

# ISOFLAMES® XL Linear Burner

## Installation, Operation, Maintenance and Owner's Manual

Burner Models:

ISFXLB24—ISFXLB36—ISFXLB48

ISFXLB60—ISFXLB72—ISFXLB96

**A PRODUCT OF EARTHCORE® INDUSTRIES, LLC**

**IMPORTANT:** This manual contains assembly rules, installation steps and guidelines, and use and maintenance instructions for ISOFLAMES XL LINEAR BURNER. This manual must become the property of and be reviewed by all current and future users of this product. It is the responsibility of the distributor, general contractor, and the installer of this product that the instructions in this manual are followed exactly and, further that the allowed gas appliance used in this product be installed in strict accordance with the gas appliance manufacturer's listing and explicit installation and operation instructions.

**INSTALLER: Leave this manual with the appliance**

**CONSUMER: Retain this manual for future reference**

**Be Sure to Read Entire Manual Before Beginning Construction.**

Contents of this manual may change without prior notification.



### WARNING:

#### FIRE OR EXPLOSION HAZARD

Failure to follow safety warning exactly could result in serious injury, death, or property damage.

- Do not store or use gasoline or other flammable vapors and liquids in the vicinity of this or any other appliance.

#### — WHAT TO DO IF YOU SMELL GAS

- Do not try to light any appliance.
  - Leave the building immediately.
  - Do not touch any electrical switch; do not use any phone in your building.
  - Immediately call your gas supplier from a neighbor's phone. Follow the gas supplier's instructions.
  - If you cannot reach your gas supplier, call the fire department.
- Installation and service must be performed by a qualified installer, service agency or the gas supplier.

**Design Certified to Z21.60 - Decorative Gas Appliance for installation in solid-fuel burning fireplace.**

The Isoflames XL Linear Burner is to be installed in solid-fuel burning fireplace with a working flue and constructed of noncombustible material. The installation including provisions for combustion and ventilation air must conform with the National Fuel Gas Code, ANSI Z223.1/NFPA 54, or the CSA B149.1 Natural Gas and Propane Installation Code, and applicable local building codes. chimney damper must be fixed in a manner that will maintain the minimum permanent vent opening at all times. A damper clamp is supplied to maintain the minimum permanent vent opening and prevent complete closure of damper flap. Warning: Solid fuels shall not be burned in a fireplace where a decorative appliance is installed.

Installation must conform to local codes. Check local codes prior to installation. In the absence of local codes, installation must conform with current National Fuel Gas Code, ANSI Z223.1.



PFS Report No. F24-348

USA: ANSI Z21.60 - 2017

Issued: February 2025

Revision 000

©2025 Earthcore Industries, LLC

**THESE FIREPLACES ARE DESIGNED FOR USE WITH:**

**PROPANE (LP) OR NATURAL GAS (NG), ONLY**

**THIS MANUAL CAN ONLY BE REPRODUCED IN ITS ENTIRETY**

# Table of Contents

Table of Contents .....	2
Isoflames XL Linear Burner - Safety Instructions .....	3-4
Isoflames XL Linear Burner - Specifications .....	5
Isoflames XL Linear Burner - Component List .....	6
Gas Line & Valve Box Installation .....	7
Valve Box & Burner Wiring Diagram .....	8
Burner Installation .....	9-10
Burner Assembly Connection .....	11-12
Remote Control System .....	13-14
Burner Lighting Instructions .....	15
End Cap Installation Instructions .....	16
Glass Media Options .....	17
Troubleshooting .....	18
Registration Card .....	19
Warranty .....	20

The latest revision of this manual may be obtained at the Earthcore website:

<https://www.earthcore.com/installation-manuals/>



**NATURAL GAS**

**ANSI Z21.60 LISTING LABEL**

**PROPANE**



PFS REPORT NO. F24-348

**ISOFLAMES XL LINEAR BURNER**  
LISTED DECORATIVE GAS APPLIANCE PER ANSI Z21.60-2017  
CSA 2.26-2017

**ISOFLAMES<sup>®</sup>**  
MADE IN THE USA  
CHESAPEAKE, VA 23323

**NOT FOR USE WITH SOLID FUEL**

SERIAL NO: **XLN00001**

GAS TYPE: NATURAL GAS (NG)  
MANIFOLD PRESSURE: 3.6" - 1.6" WC

MINIMUM INLET GAS SUPPLY PRESSURE: 5" WC  
MAXIMUM INLET GAS SUPPLY PRESSURE: 10.5" WC

**FOR USE WITH NATURAL GAS (NG) ONLY**

- ISFXLB24N MAX BTU 50,000; MIN BTU 37,000
- ISFXLB36N MAX BTU 75,000; MIN BTU 56,000
- ISFXLB48N MAX BTU 110,000; MIN BTU 73,000
- ISFXLB60N MAX BTU 125,000; MIN BTU 84,000
- ISFXLB72N MAX BTU 150,000; MIN BTU 108,000
- ISFXLB96N MAX BTU 205,000; MIN BTU 155,000

**MINIMUM FIREPLACE DIMENSIONS (in):**

MODEL	DEPTH	HEIGHT	REAR WIDTH	FRONT WIDTH	CHIMNEY OPENING (in <sup>2</sup> )
24	17.5	20	25	36	32
36	17.5	20	37	48	46
48	17.5	20	49	60	65
60	17.5	20	61	72	73
72	17.5	20	73	84	87
96	17.5	20	97	108	116

EARTHCORE INDUSTRIES HEADQUARTERS - 6899 PHILLIPS INDUSTRIAL BLVD JACKSONVILLE, FL 32256



PFS REPORT NO. F24-348

**ISOFLAMES XL LINEAR BURNER**  
LISTED DECORATIVE GAS APPLIANCE PER ANSI Z21.60-2017  
CSA 2.26-2017

**ISOFLAMES<sup>®</sup>**  
MADE IN THE USA  
CHESAPEAKE, VA 23323

**NOT FOR USE WITH SOLID FUEL**

SERIAL NO: **XLP00001**

GAS TYPE: PROPANE (LPG)  
MANIFOLD PRESSURE: 10" - 6.4" WC

MINIMUM INLET GAS SUPPLY PRESSURE: 11" WC  
MAXIMUM INLET GAS SUPPLY PRESSURE: 14" WC

**FOR USE WITH PROPANE (LP) ONLY**

- ISFXLB24P MAX BTU 45,000; MIN BTU 33,000
- ISFXLB36P MAX BTU 65,000; MIN BTU 51,000
- ISFXLB48P MAX BTU 85,000; MIN BTU 68,000
- ISFXLB60P MAX BTU 114,000; MIN BTU 88,000
- ISFXLB72P MAX BTU 142,000; MIN BTU 110,000
- ISFXLB96P MAX BTU 185,000; MIN BTU 143,000

**MINIMUM FIREPLACE DIMENSIONS (in):**

MODEL	DEPTH	HEIGHT	REAR WIDTH	FRONT WIDTH	CHIMNEY OPENING (in <sup>2</sup> )
24	17.5	20	25	36	30
36	17.5	20	37	48	41
48	17.5	20	49	60	52
60	17.5	20	61	72	67
72	17.5	20	73	84	82
96	17.5	20	97	108	106

EARTHCORE INDUSTRIES HEADQUARTERS - 6899 PHILLIPS INDUSTRIAL BLVD JACKSONVILLE, FL 32256

## **Isoflames XL Linear Burner - Safety Instructions**

**WARNING!!!** This appliance assembly contains burner orifices specifically for the input gas specified on the burner and box, as well as the BTU rating specified in this manual. Modifying or failure to use the factory orifice may cause property damage, personal injury, or loss of life.

Read these instructions completely before installing and using ISOFLAMES XL Linear Burner.

1. Solid fuels shall not be burned in any fireplace where a decorative appliance has been installed.
2. The minimum inlet supply pressure for the purpose of input adjustment is 5.0 inches (natural gas) 11.0 inches (propane) in water column. The maximum inlet supply pressure is 10.5 inches (natural gas) 13.0 inches (propane) in water column.
3. Gas type will be indicated on the burner rating plate. Do not use a natural gas burner with propane or a propane burner with natural gas. Appliance is not convertible to use other gases.
4. The installation, provisions for combustion, and ventilation air must conform to the National Fuel Gas Code, ANSI Z223.1/ NFPA 54, or the Natural Gas and Propane Installation code, CSA B149.1.
5. The appliance and its main gas valve must be disconnected from the gas supply piping system during any pressure testing of that system at test pressures in excess of 1/2 psi (3.5 kPa). The appliance must be isolated from the gas piping system by closing its equipment shutoff valve during any pressure testing of the supply piping system at test pressures equal to or less than 1/2 psi (3.5 kPa).
6. Do not use this appliance if any part has been under water. Immediately call a qualified service technician to inspect the appliance and to replace any part of the control system and any gas control which has been under water.
7. Periodic examination and cleaning of the venting system of the solid fuel burning fireplace, including frequency of such examination and cleaning, by a qualified agency.
8. The appliance area is to be clear and free from combustible materials, gasoline and or flammable vapors and liquids. For warranty to be valid gas log sets must be installed by a NFI certified or other qualified professional installer.
9. Always check local building codes governing fireplaces and fireplace installations. ISOFLAMES Linear Burner installation must comply with all local, regional, state, and national codes and regulations.
10. This appliance is only for use with the type of gas indicated on the rating plate. This appliance SHALL NOT be field converted for use with other gases with Propane (LP) or Natural Gas (NG).
11. This appliance shall only be installed, serviced, or inspected by qualified professional service technician.
12. For propane (LP) use do not place propane supply tank(s) inside any structure. Locate propane supply tank(s) outdoors.
13. To prevent performance problems, do not use propane fuel tank of less than 100 lbs. capacity.
14. This decorative gas appliance reaches high temperature. Keep children and adults away from hot surfaces to avoid burns or clothing ignition. Fireplace will remain hot for a time after shutdown. Allow surfaces to cool before touching.
15. Turn the appliance off and allow to cool before servicing. Always shut off any electricity and gas to the appliance while working on it. Only a qualified service person should install, service or repair this appliance. Have your appliance inspected annually by a qualified service person.
16. It is imperative that the unit's control areas, burners and circulation air passages be kept clean.
17. Keep all combustible material, gasoline, and other flammable liquids at a safe distance from the fireplace. Do not use the appliance where these items are used or stored. Decorations, clothing, and other such combustible items should not be placed on the appliance.
18. Do not cook food or burn paper or other object(s).
19. Do not use any solid fuels - wood, coal, paper, cardboard, etc. - Use only the gas type listed on the fireplace's burner rating plate.
20. Do not in any way obstruct the flow of combustion and ventilation air. Provide adequate clearances around air openings into the combustion chamber as well as adequate accessibility clearances for servicing and proper operation.

## **Isoflames XL Linear Burner - Safety Instructions**

21. Never install an ISOFLAMES XL Linear Burner component or accessory that has visible or suspected physical damage. These items should be inspected by a qualified representative to ensure safe condition. When in doubt, consult your local supplier.
22. Do not alter or modify the ISOFLAMES XL Linear Burner or burner components under any circumstances. Modification or alteration of any sort may void manufacturer's warranty, listings, and approvals.
23. The ISOFLAMES XL Linear Burner system is not intended to heat an entire home or to be used as a primary heat source.
24. Children and adults should be alerted to the hazards of high surface temperature and should stay away from this appliance to avoid burns or clothing ignition.
25. Young children should be carefully supervised when they are in the same room as the appliance. Toddlers, young children, and others may be susceptible to accidental contact burns. A physical barrier is recommended if there are at-risk individuals in the house. To restrict access to the fireplace, install an adjustable safety gate to keep toddlers, young children and other at-risk individuals out of the room and away from hot surfaces.
26. Clothing or flammable material should not be placed on or near the appliance.
27. Due to high temperatures, the appliance should be located out of traffic and away from furniture and draperies.
28. Any safety screen, guard, or barrier removed for servicing an appliance must be replaced prior to operating the appliance.
29. Installation and repair should be done by a qualified service person. The appliance should be inspected before use and at least annually by a professional service person. More frequent cleaning may be required due to excessive lint from carpeting, bedding material, etcetera. It is imperative that control compartments, burners, and circulating air passageways of the appliance be kept clean.
30. A fireplace screen must be in place when the appliance is operating and the screen shall have an opening(s) for introduction of combustion air

**WARNING!!!: This product contains or generates chemicals known to the state of California to cause cancer or birth defects or other reproductive harm.**

**IMPORTANT: Read this owner's manual carefully and completely before trying to assemble, operate or service this fireplace. Improper use of this fireplace can cause serious injury or death from fire, burns, explosions and carbon monoxide poisoning.**

**DANGER!!!: CARBON MONOXIDE POISONING MAY LEAD TO DEATH!**

Propane (LP) gas and natural gas (NG) are both colorless and odorless gases. An odor making agent is added to each of these gases to help you detect a gas leak. However, the odor added to these gases can fade and gas may be present even though no odor exists.

Carbon Monoxide Poisoning: Early signs of carbon monoxide poisoning resemble flu symptoms, including headaches, dizziness or nausea. If you have these signs the fireplace may not have been installed properly, get fresh air at once! Have the fireplace inspected and serviced by a qualified service person or your gas supplier. Some people are more affected by carbon monoxide than others. These include pregnant women, people with heart or lung diseases or anemia, people at high altitude or under the influence of alcohol. Earthcore Industries strongly recommends the use of a carbon monoxide detector/alarm device wherever gas fired appliances are in use.

All parties either involved in or associated with the installation, service and use of this fireplace must read this entire manual. Keep this manual for reference and as a guidebook to safe operation of this fireplace.

**WARNING!!!: This unit is not for use with solid fuel.**

## Isoflames XL Linear Burner - Specifications

**TABLE 1**

<b>Burner Specifications</b>								
<b>Burner Model</b>	<b>Minimum Fireplace Dimension (in)</b>				<b>BTU</b>			
	<b>Depth</b>	<b>Height*</b>	<b>Width</b>		<b>Nat. Gas</b>		<b>L.P. Gas</b>	
			<b>Front</b>	<b>Rear</b>	<b>High</b>	<b>Low</b>	<b>High</b>	<b>Low</b>
ISFXLB24	17.5	23	36	25	50K	37K	45K	33K
ISFXLB36	17.5	23	48	37	75K	56K	65K	51K
ISFXLB48	17.5	23	60	49	110K	73K	85K	68K
ISFXLB60	17.5	23	72	61	125K	84K	114K	88K
ISFXLB72	17.5	23	84	73	150K	108K	140K	110K
ISFXLB96	17.5	23	108	97	205K	155K	185K	143K

*\* Height is measured from hearth floor to bottom of lintel*

**TABLE 2**

<b>MINIMUM VENTING REQUIREMENTS</b>						
<b>CHIMNEY HEIGHT* (ft)</b>	<b>MINIMUM PERMANENT FREE OPENING OF CHIMNEY DAMPER (sq. in)</b>					
	<b>FACTORY-BUILT FIREPLACE</b>					
	<b>ISFXLB24</b>	<b>ISFXLB36</b>	<b>ISFXLB48</b>	<b>ISFXLB60</b>	<b>ISFXLB72</b>	<b>ISFXLB96</b>
<b>15</b>	<b>21.2</b>	<b>35.8</b>	<b>56.9</b>	<b>66.0</b>	<b>81.1</b>	<b>114.4</b>
<b>20</b>	<b>18.1</b>	<b>29.7</b>	<b>47.2</b>	<b>54.7</b>	<b>67.2</b>	<b>94.8</b>
<b>25</b>	<b>15.9</b>	<b>25.8</b>	<b>42.8</b>	<b>50.1</b>	<b>62.3</b>	<b>89.8</b>
<b>30</b>	<b>14.5</b>	<b>23.3</b>	<b>37.9</b>	<b>44.2</b>	<b>54.6</b>	<b>77.6</b>
<b>MASONRY-BUILT FIREPLACE</b>						
<b>15</b>	<b>32</b>	<b>45.8</b>	<b>64.7</b>	<b>72.8</b>	<b>86.3</b>	<b>116</b>
<b>20</b>	<b>28.8</b>	<b>41.6</b>	<b>58.5</b>	<b>65.8</b>	<b>77.9</b>	<b>104.5</b>
<b>25</b>	<b>26.5</b>	<b>37.7</b>	<b>52.8</b>	<b>59.2</b>	<b>69.9</b>	<b>93.5</b>

*\* Chimney height is measured from hearth to top of chimney.*

## Isoflames XL Linear Burner - Components List

①

NOTE: single burner segment shown

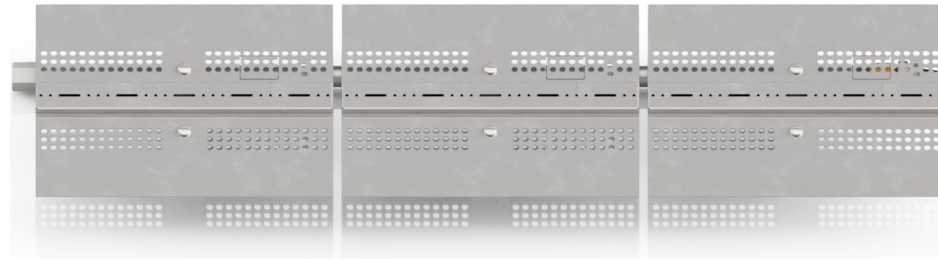

Top view

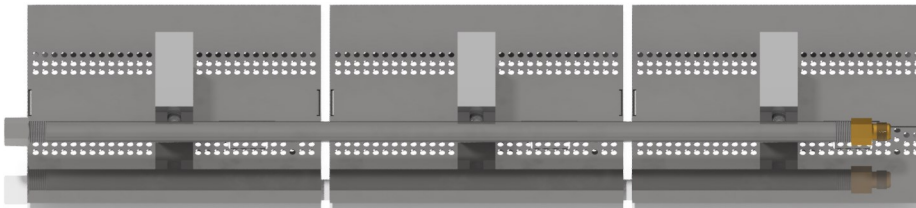

Bottom view

②



③

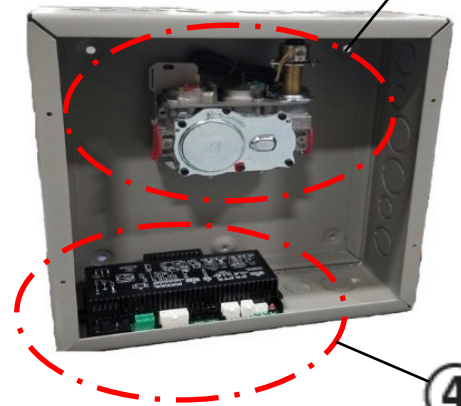

④

⑦



⑥



⑧\*



⑤



⑨\*

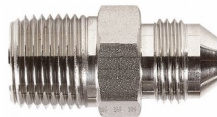

**TABLE 3**

Item No.	Description	Part No.	Qty
1	Main Burner Assembly (natural gas)	ISF-E-XLB36/48/60/72/96N	1
	Main Burner Assembly (propane)	ISF-E-XLB36/48/60/72/96P	1
2	Pilot Assembly (natural gas)	ISF-E-PAN	1
	Pilot Assembly (propane)	ISF-E-PAP	1
3	Gas Valve (natural gas)	ISF-E-GVN	1
	Gas Valve (propane)	ISF-E-GVP	1
4	Control Module/Remote Receiver	ISF-E-ICM	1
5	Wall Mount Remote Transmitter	ISF-E-RMT	1
6	3/4" NPT Valve Hex Adapter	P-GAS-ADP-000	1
7	Flared Fitting Female Adapter	E-12FF-34FIP	1
*8	Tee (Only for model ISFXLB96N/P)	P-GAS-TEE-000	1
*9	Flared Fitting Male Adapter (Only for model ISFXLB96N/P)	E-12FF-34MIP	2

## Gas Line & Valve Box Installation

This appliance must be connected to the gas line in accordance with local codes and/or the National Fuel Gas Code, ANSI Z223.1. After connecting the gas line, all joints in the line and connections at the valve should be checked for leaks before final positioning of the unit. Conduct a gas leakage test of the appliance piping and control system downstream of the shutoff valve in the supply line to the appliance.

- 1) The valve control box comes with an 110" pilot assembly lead; therefore, the box must be mounted within 7' of the fireplace for models ISFXLB36/48/60/72 and within 2' for model ISFXLB96. **(Figure 1)**.
- 2) Attach the metal enclosure to the studs using standard building materials. The metal enclosure must be mounted in a location that can be accessed in the future for additional connections & future servicing.
- 3) Installation and servicing of gas appliances and ignition systems must only be performed by qualified personnel.
- 4) Turn off gas and electricity before starting installation or service.
- 5) Make sure gas piping is pressure tested before control is connected. High pressure can damage the control causing a hazardous condition.
- 6) Make sure piping is clean and free from burrs. Apply a small amount of good quality gas-rated pipe thread compound or plumbers' tape suitable for the gas being used. Thread compound should be used sparingly on male threads only, leaving the first two threads clean.
- 7) It is recommended that a safety shut off valve is installed on either the gas in or gas outside of the valve.
- 8) It is recommended to hard pipe in the connections with unions installed inside the box.
- 9) Uncoil the pilot assembly. Be careful to not create unwanted kinks in the pilot tubing.
- 10) Feed the spade connector ends of the pilot assembly from inside the fireplace to the outside being careful not to clog the flared fitting of the pilot tube or damage the spade connectors.
- 11) Plug the spade connectors into the module according to the wiring diagram **(Figures 2 & 3)**, insert the pilot tubing into the right side of the valve and, using a wrench, tighten the nut so that the pilot tubing cannot be pulled out.

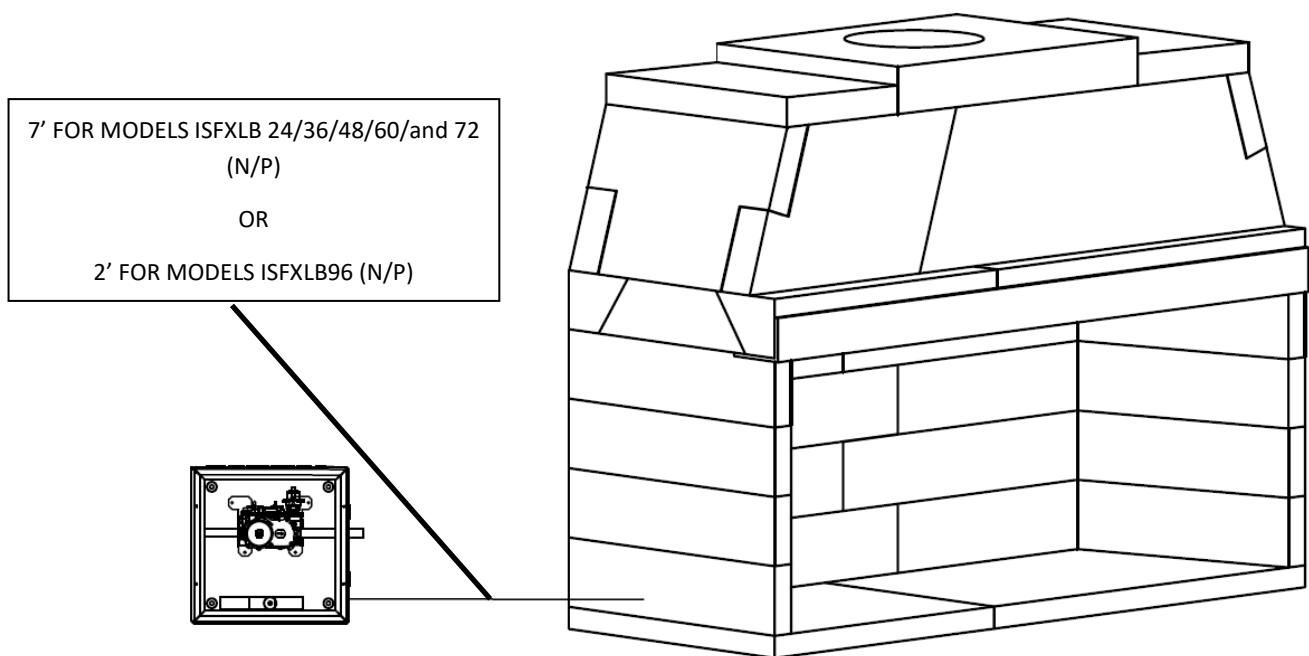

FIGURE 1

## Valve Box & Burner Wiring Diagram

**WARNING!!!: Do not connect 120 VAC to the control valve.**

The appliance and its appliance main gas valve must be disconnected from the gas supply piping system during and pressure testing of that system at test pressures in excess of 1/2 psi (3.5 kPa).

The appliance, when installed, must be electrically grounded in accordance with local codes or in the absence of local codes, with the National Electrical Code, ANSI/NFPA 70. If not installed and maintained in accordance with the manufacturer's instructions, this product could expose you to substances in fuel or fuel combustion which are known to the state of California to cause cancer, birth defects or other reproductive harm.

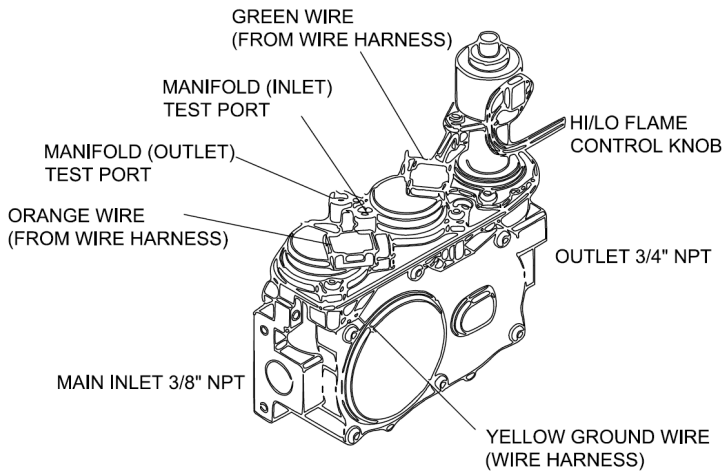

**TABLE 4**

Fuel Type	Inlet Pressure			Manifold Pressure	
	Desired	Minimum	Maximum	On Hi Fire	On Lo Fire
Natural Gas	7" WC	5" WC	10.5" WC	3.5" WC	1.6" WC
LP Gas	11" WC	10.5" WC	13" WC	10" WC	6.4" WC

**FIGURE 2**

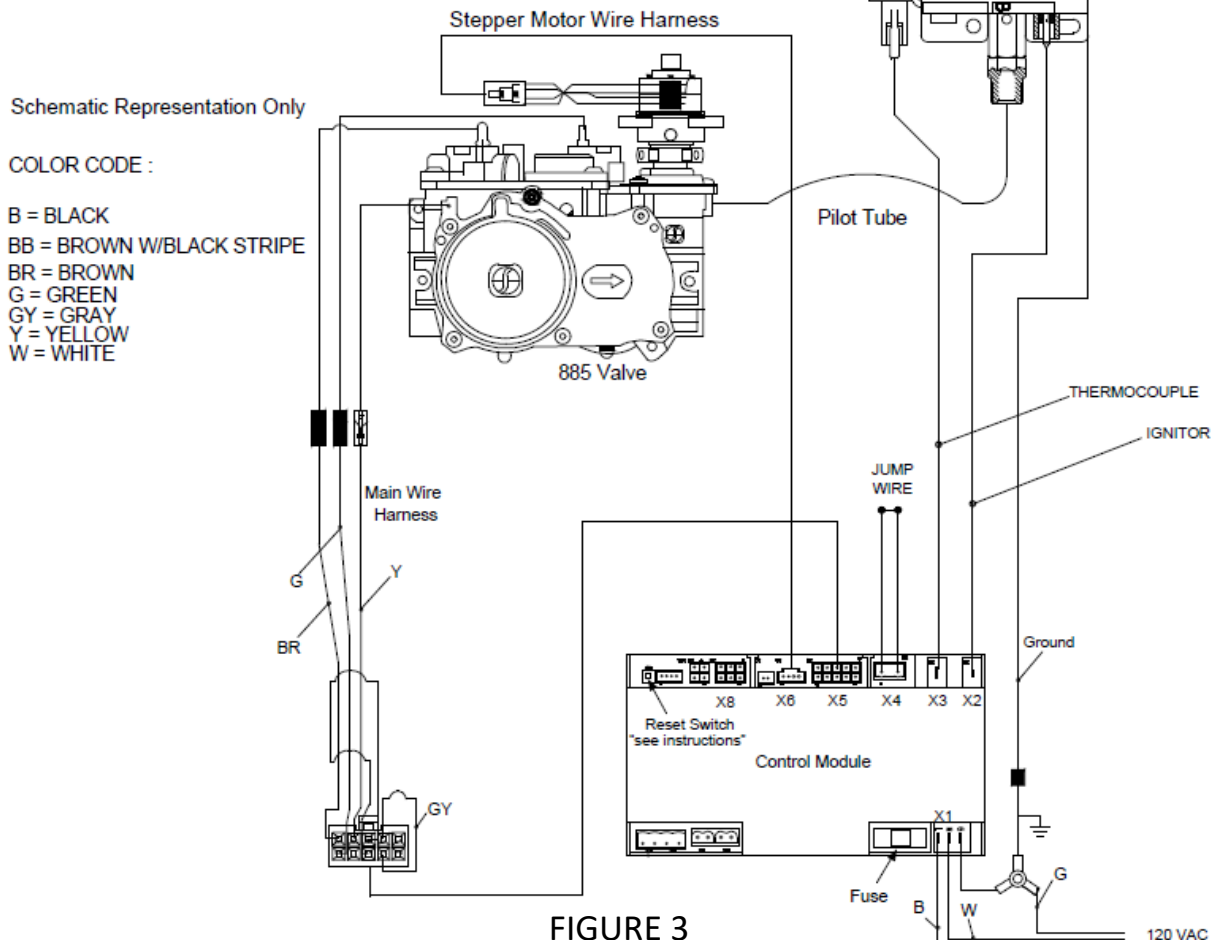

**FIGURE 3**



## Burner Installation

**IMPORTANT:** Prior to installation: Shut off main gas supply to fireplace.

- 1) The ISOFLAMES XL Linear Burner system shall be installed by qualified professional service technician. To ensure proper performance of the appliance the owner’s installation manual must be followed carefully.
- 2) The ISOFLAMES XL Linear Burner must be installed on top of minimum 1-1/4" "split" firebrick. **Figure 4 & 5**
- 3) The ISOFLAMES XL Linear Burner is designed to be recessed into a 2-1/2" deep firebrick cavity.
- 4) The burner cavity must have a height of 2-1/2", a depth of approximately 9", and the length shall extend the entire length of firebox. **(Table 5; Figure 4 & 5)**
- 5) The ISFXLB24/36/48/60/72 (N/P) (respectively): Gas supply piping for these models shall terminate not less than 3" from sidewall. **(Figure 6)**
- 6) The ISFXLB96 (N/P) (respectively): Gas supply stub piping for this model shall terminate within 3" from center of the cavity. **(Figure 6)**

**TABLE 5**

<b>BURNER CAVITY DIMENSIONS (in)</b>			
<b>Burner Model</b>	<b>Height</b>	<b>Width</b>	<b>Length</b>
ISFXLB24	2-1/2"	≈9"	FULL
ISFXLB36	2-1/2"	≈9"	FULL
ISFXLB48	2-1/2"	≈9"	FULL
ISFXLB60	2-1/2"	≈9"	FULL
ISFXLB72	2-1/2"	≈9"	FULL
ISFXLB96	2-1/2"	≈9"	FULL

*Note: make sure cavity length has enough space for gas supply line.*

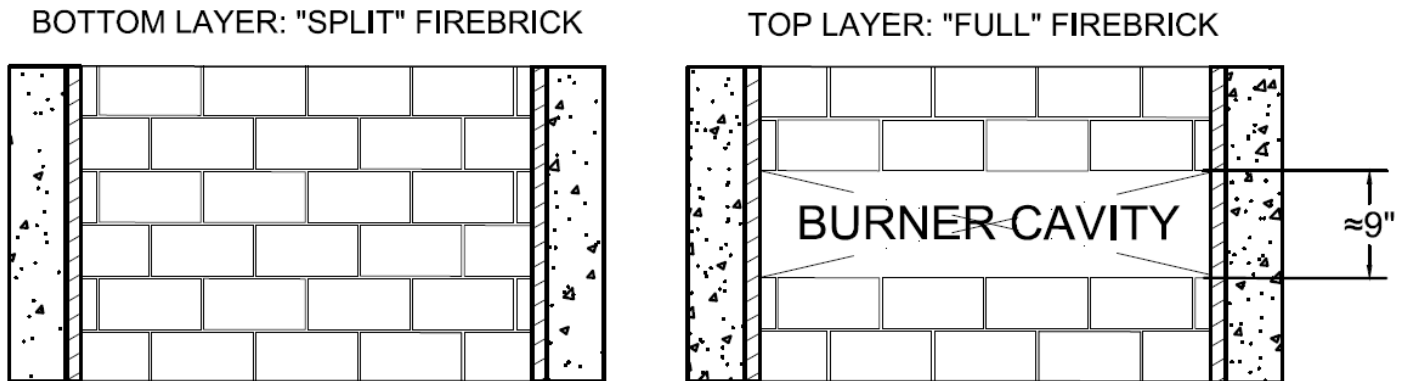

**FIGURE 4**

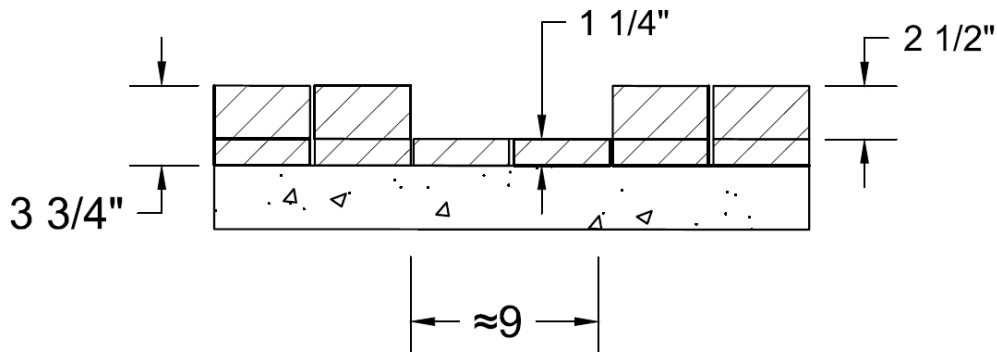

**FIGURE 5**

## Burner Installation

- 1) Connect all burner segments according to burner model diagram Page 11-12. Make sure all connections are tightly secured.
- 2) Place burner assembly in center of fireplace floor/cavity.
- 3) Rotate the burner to position the gas inlet flared fitting to be on same side as the gas-supply stub coming from the gas valve. (Not necessary for models ISFXLB96 (N/P))
- 4) Remove the burner top closest to the gas-supply stub. Remove the top pan by unscrewing the two screws. This will allow easier access and connection of flex connector to the flared fitting. This will also be used for pilot assembly installation.
- 5) Ensure the appropriate 3/4" flared fitting is connected to the gas supply stub.
- 6) Connect the 12" flex connector to the gas inlet flared fitting on the burner assembly.
- 7) Connect the other end of 12" flex connector to the gas-supply.
- 8) Avoid creating kinks in the flex connector.
- 9) Make sure all connections are tightly secured.
- 10) Before replacing the removed burner top from **step 4**, locate the perforated rectangular section in the pan. Gently remove this section along the perforations using a screwdriver or pliers. **(Figure 7)**
- 11) Insert the pilot assembly from underneath the existing burner pan to the area of the removed burner section. **(Figure 8)**
- 12) Mount the pilot assembly to the removed burner pan using the screws provided with the pilot assembly. Be careful not to kink the pilot assembly tube as it can severely damage the pilot tube. **(Figure 9)**
- 13) Place the removed burner top back on to the orifice block and secure tightly with the pan head screws.
- 14) With gas line installed, complete burner lighting instructions on page 15.

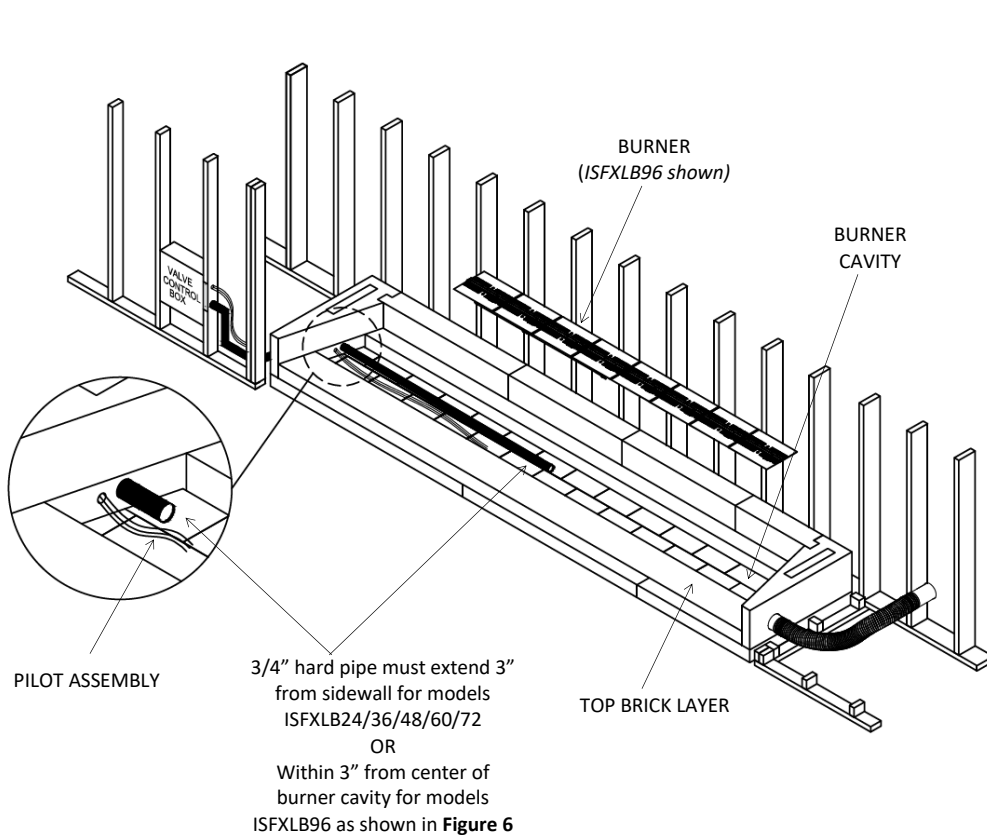

FIGURE 6

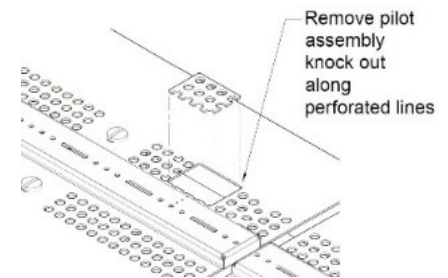

FIGURE 7

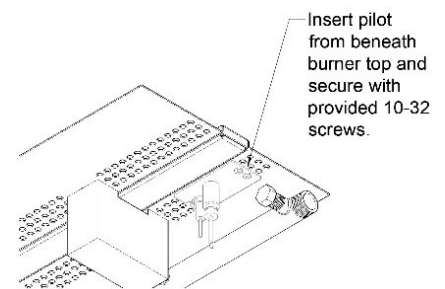

FIGURE 8

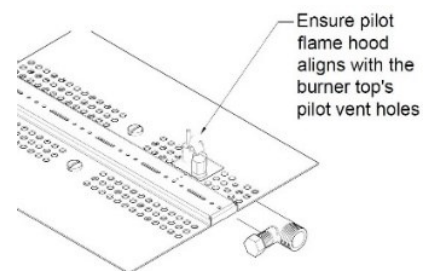
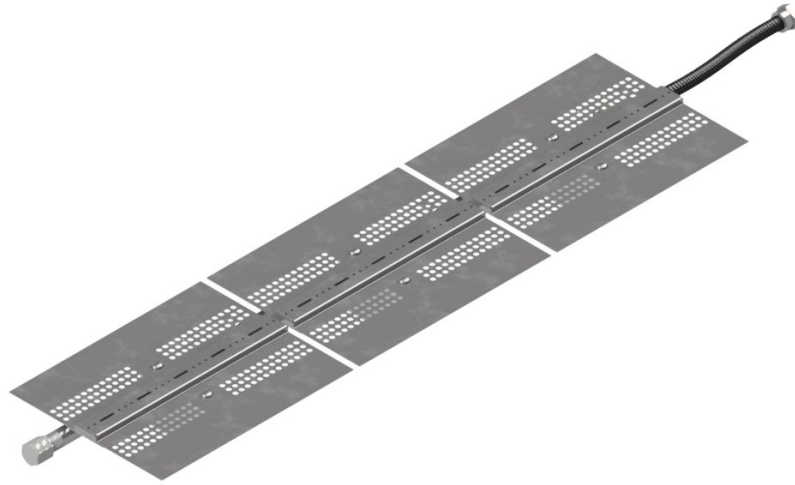

FIGURE 9

*\*Typical installation*

### **36" Burner Connection - ISFXLB36 (N/P)**



### **48" Burner Connection - ISFXLB48 (N/P)**

<b>ISFXLB48</b>
<b>SECTION</b>
A
B

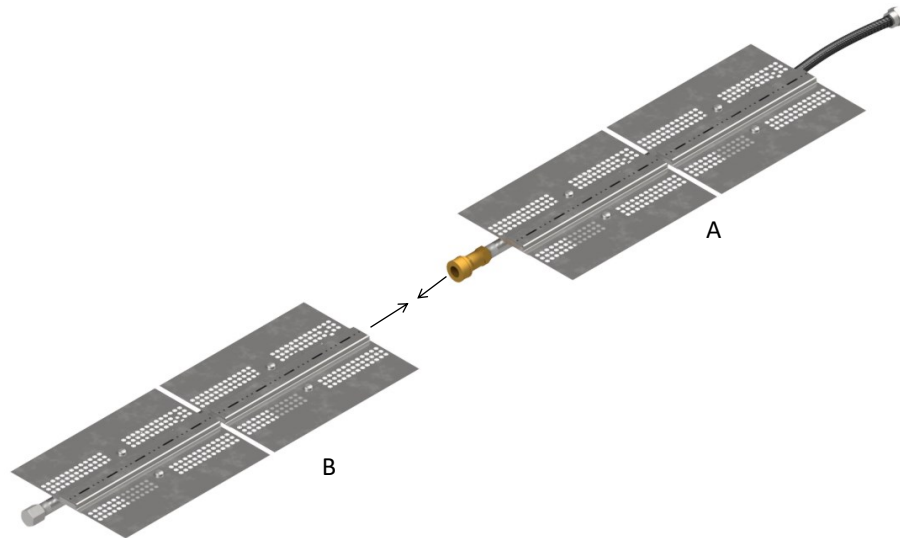

### **60" Burner Connection - ISFXLB60 (N/P)**

<b>ISFXLB60</b>
<b>SECTION</b>
A
B

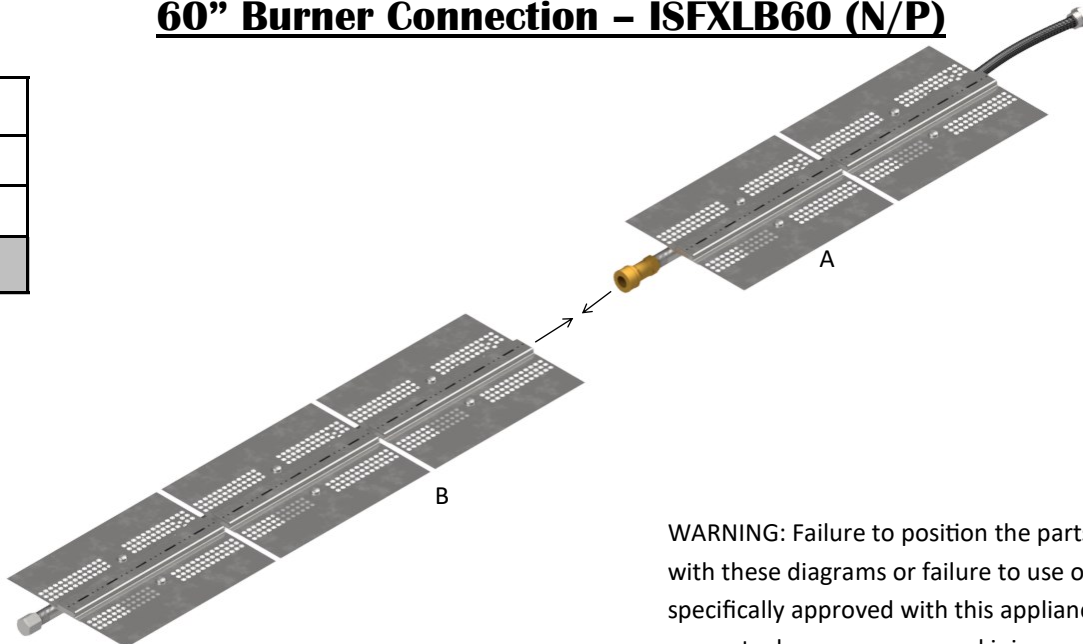

**WARNING:** Failure to position the parts in accordance with these diagrams or failure to use only parts specifically approved with this appliance may result in property damage or personal injury.

## 72" Burner Connection – ISFXLB72 (N/P)

<b>ISFXLB72</b>
<b>SECTION</b>
A
B

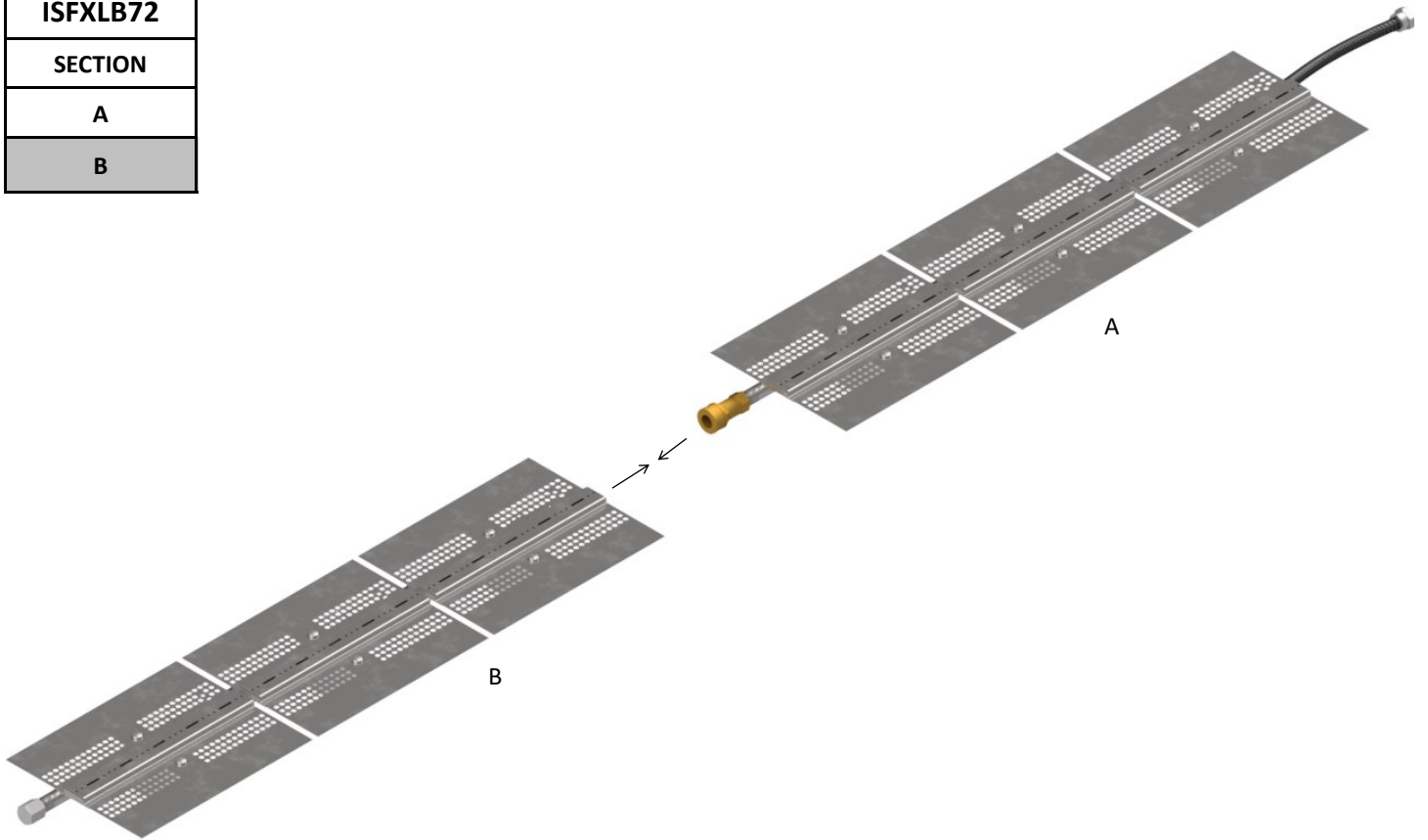

## 96" Burner Connection – ISFXLB96 (N/P)

<b>ISFXLB96</b>
<b>SECTION</b>
A(x2)
B(x2)

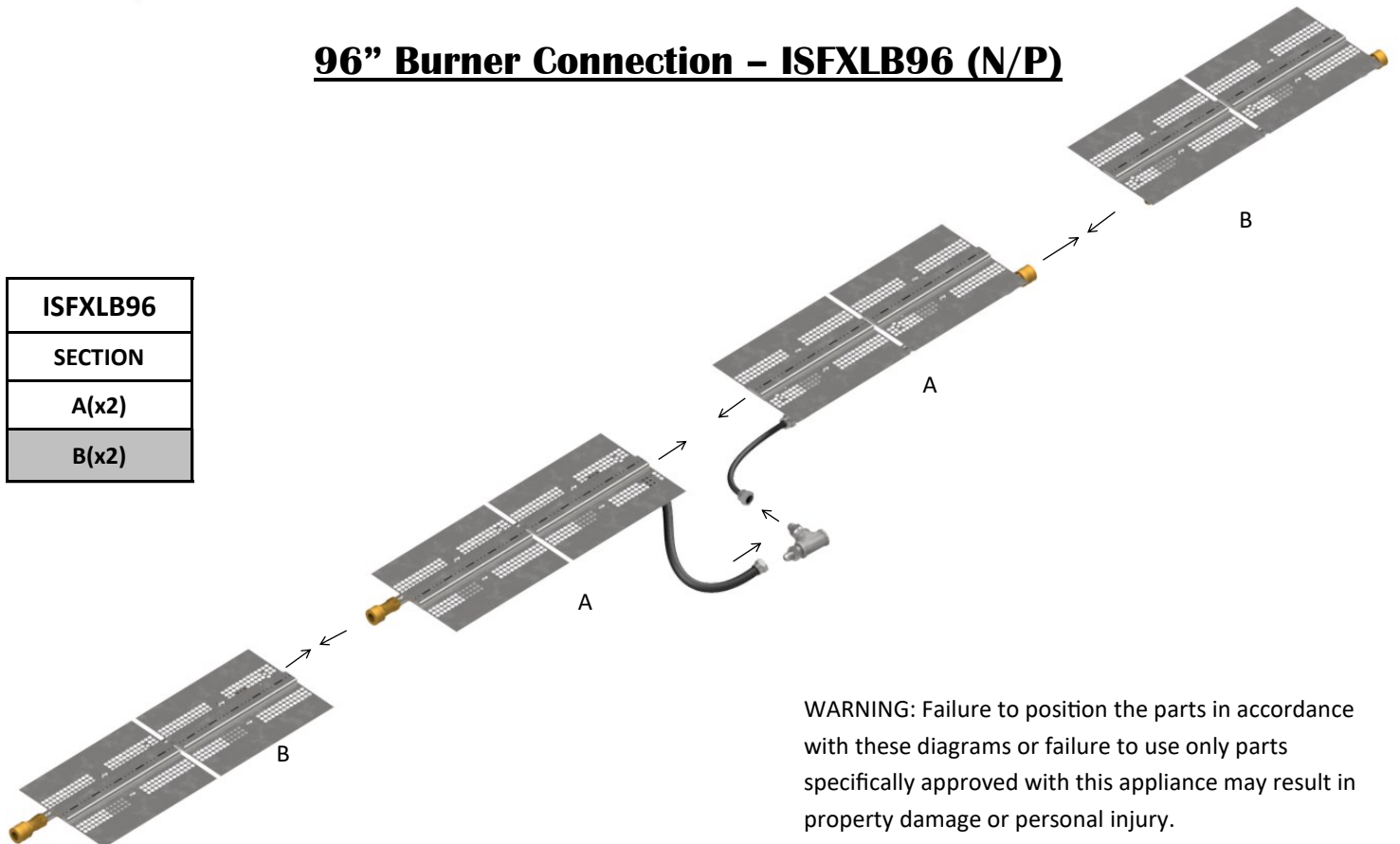

**WARNING:** Failure to position the parts in accordance with these diagrams or failure to use only parts specifically approved with this appliance may result in property damage or personal injury.

## Remote Control System

The Remote allows you to command the functions of your appliance from the comfort of your chair and is configured to control the On/Off primary burner operation, its flame height through six (6) levels, and provides On/Off control of the appliance.

### SYNCHRONIZE REMOTE TO CONTROL MODULE FOR THE FIRST TIME

1. Insert the three (3) provided AAA batteries into the battery bay in the remote. Correctly align polarity (+/-).
2. Press the red SW1 button on the control module. The control module will beep 3 times and an amber LED is illuminated to indicate that the control module is ready to synchronize with a remote within 10 seconds.
3. Push the "ON" button on the remote (**Figure 10**). The control module will beep four (4) times to indicate acceptance of the remote's command. The system is now synchronized.

### TURN ON THE APPLIANCE

Press the ON/OFF Key on the Remote. The Remote LCD display will only show all active Icons on the screen and the appliance burner will turn on. A single "beep" from the module confirms reception of the command.

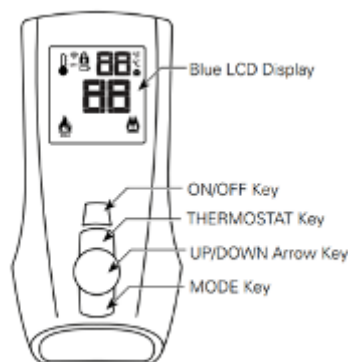

FIGURE 10

### REMOTE FLAME CONTROL

The system has six (6) flame levels. See (**Figure 10**) for an example. With the system on, and the flame level at the maximum in the appliance, pressing the "Down Arrow Key" once will reduce the flame height by one step until the flame is turned off. The "Up-Arrow Key" will increase the flame height each time it is pressed. If the "Up Arrow Key" is pressed while the system is on, but the flame is off, the flame will come on in the high position (**Figure 11**). A single "beep" will confirm reception of the command.

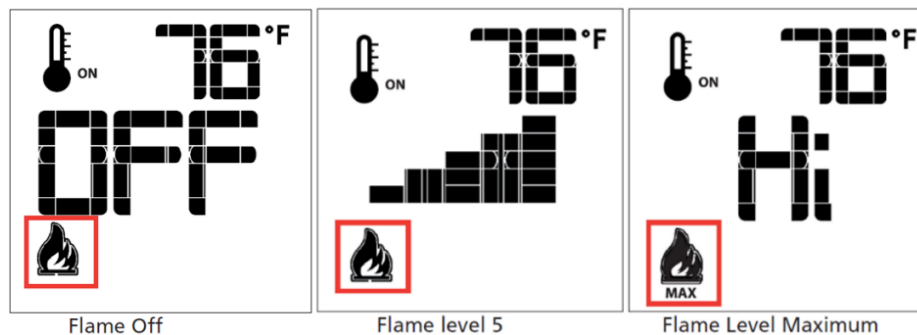

FIGURE 11

**WARNING!!!** Fire hazard. Can cause severe injury or death. The receiver causes ignition of the appliance. The appliance can turn on suddenly. Keep away from the appliance burner when operating the remote system or activating manual bypass of the remote system.

**WARNING!!!** Property damage hazard. Excessive heat can cause property damage. The appliance can stay lit for many hours. Turn off the appliance if it is not going to be attended for any length of time. Always place the Transmitter where children cannot reach it.

## Remote Control System

### TEMPERATURE INDICATOR DISPLAY

With the system in the “OFF” position, press the “**Thermostat**” Key and the “**Mode**” Key at the same time (Figure 10). Look at the LCD screen on the Remote to verify that a °C or °F is visible to the right of the Room Temperature display (Figure 12).

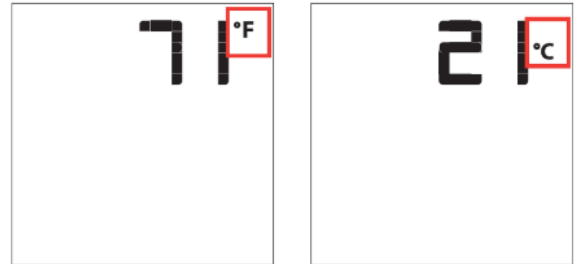

FIGURE 12

### TURN OFF THE APPLIANCE

Press the “**ON/OFF**” Key on the Remote. The Remote LCD display will only show the room temperature and Icon and the appliance will turn off. A single “beep” from the Receiver confirms reception of the command.

### LOW BATTERY POWER DETECTION

The life span of the Remote batteries depends on various factors: quality of the batteries used, the number of ignitions of the appliance, the number of changes to the room thermostat set point, etc.

When the Remote batteries are low, a Battery icon will appear on the LCD display of the remote (Figure 13) before all battery power is lost. When the batteries are replaced this icon will disappear.



FIGURE 13

### CONTINUOUS PILOT (CPI) & INTERMITTENT PILOT (IPI) SELECTION

With the system in “OFF” position press the “**Mode**” Key (Figure 10) to index to the **CPI** mode icon. Pressing the “**UP Arrow Key**” will return to **IPI**. A single “beep” will confirm the reception of the command (Figure 14). Remote default setting is set to **IPI**.

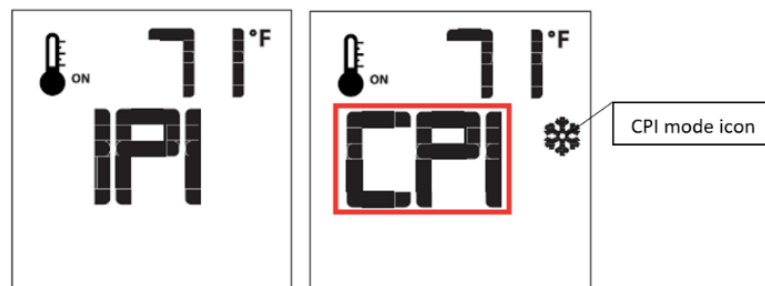

FIGURE 14

**WARNING!!!:** Fire hazard. Can cause severe injury or death. The receiver causes ignition of the appliance. The appliance can turn on suddenly. Keep away from the appliance burner when operating the remote system or activating manual bypass of the remote system.

**WARNING!!!:** Property damage hazard. Excessive heat can cause property damage. The appliance can stay lit for many hours. Turn off the appliance if it is not going to be attended for any length of time. Always place the Transmitter where children cannot reach it.

## Burner Lighting Instructions

### INSTALLER INSTRUCTIONS

It is required that the set of safety instruction labels that have been supplied with the appliance be affixed to the operation and control points of the appliance. It is the installer's responsibility to ensure these warnings are properly affixed during installation. These warning labels are a critical step in informing consumers of safe operation of this appliance.

### PRE-LIGHTING CHECKLIST

Be sure to check these items before the initial lighting of the appliance:

- Gas pressure has been checked carefully.
- All gas fittings have been checked for leaks.
- All clearances to combustibles have been met.
- All combustible materials have been removed from the area in front of the appliance.
- All vented areas of the appliance face are unobstructed .
- House is ventilated to clear initial paint curing odors.
- All packaging materials have been removed from the appliance.
- While appliance is cool, fingerprints or other marks have been cleaned from any plated surfaces with denatured alcohol and a soft cloth. Marks left on these surfaces may become permanent into the finish if not removed prior burning the unit.

**WARNING!!!: IF YOU DO NOT FOLLOW THESE INSTRUCTIONS EXACTLY, A FIRE OR EXPLOSION MAY RESULT CAUSING PROPERTY DAMAGE, PERSONAL INJURY OR LOSS OF LIFE.**

### SAFETY INSTRUCTIONS

- A. This appliance is equipped with an ignition device which automatically lights the pilot. Do NOT try to light the pilot by hand.
- B. BEFORE OPERATING, smell all around the appliance area for gas. Be sure to smell next to the floor because some gas is heavier than air and will settle on the floor.
- **WHAT TO DO IF YOU SMELL GAS:**
  - **Do not try to light any appliance.**
  - **Do not touch any electric switch; do not use any phone in your building.**
  - **Immediately call your gas supplier from a neighbor's phone. Follow the gas supplier's instructions.**
  - **If you cannot reach your gas supplier, call the fire department.**
- C. If any portion of this appliance does not operate as the instructions indicate, do not try to repair it, call a qualified service technician. Do not use tools. Force or attempted repair may result in a fire or explosion.
- D. **Do not use this appliance if any part has been under water.** Immediately call a qualified service technician to inspect the appliance and to replace any part of the system and any gas control which has been under water.

### Main Power and Remote Overview

The jumper wire needs to be installed on Terminal X4 on the control module. Once X4 is jumpered, the REMOTE functions as a burner and pilot override switch.



JUMP WIRE

### Remote Lighting Instructions

Press ON/OFF on Remote transmitter. Module will beep one time to confirm. Pilot will begin to spark. It may take several minutes for air to purge from pilot tube. Once pilot is ignited, the main burner will turn on.

### TO TURN OFF GAS TO APPLIANCE

1. Press the "ON/OFF" key on remote to turn off appliance operation.
2. Turn off all electric power to the appliance if service is to be performed.
3. Close the main line gas shut-off valve.

## BURNER CAVITY END CAP INSTALLATION

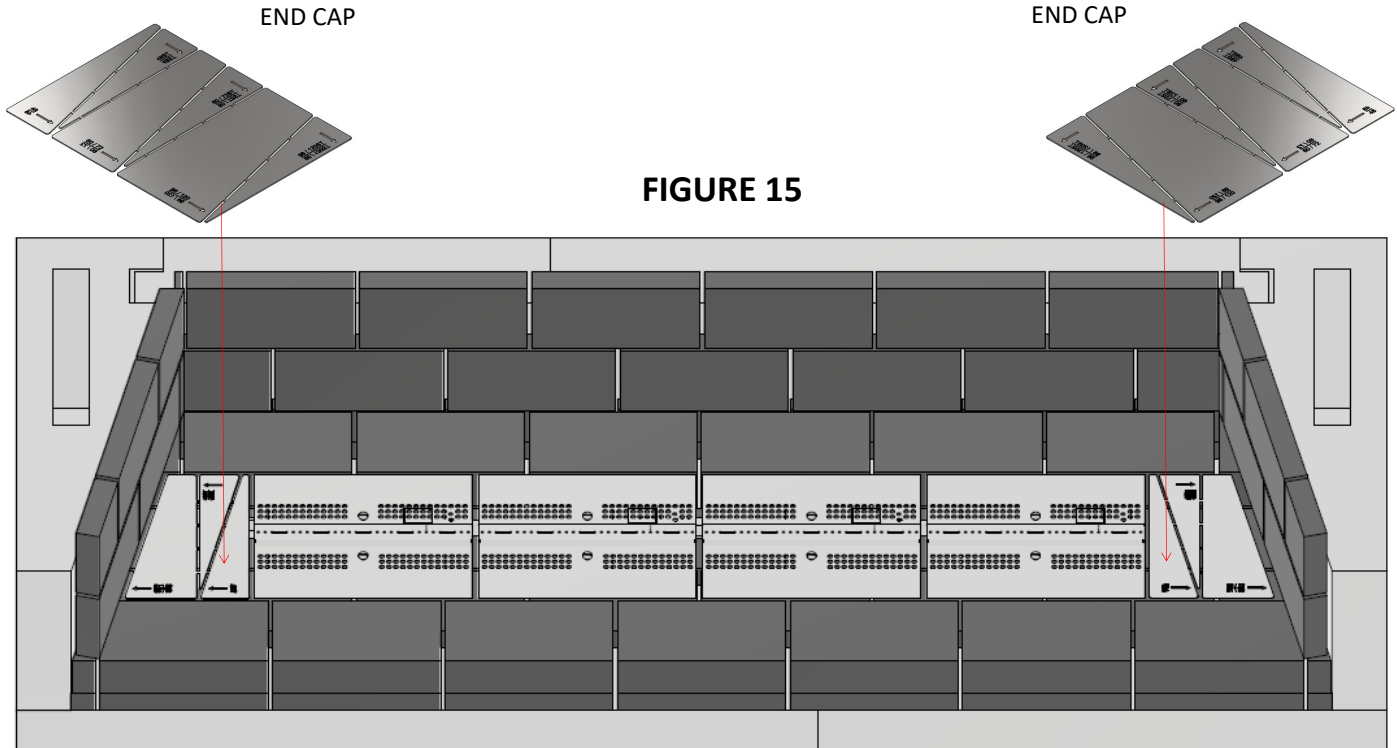
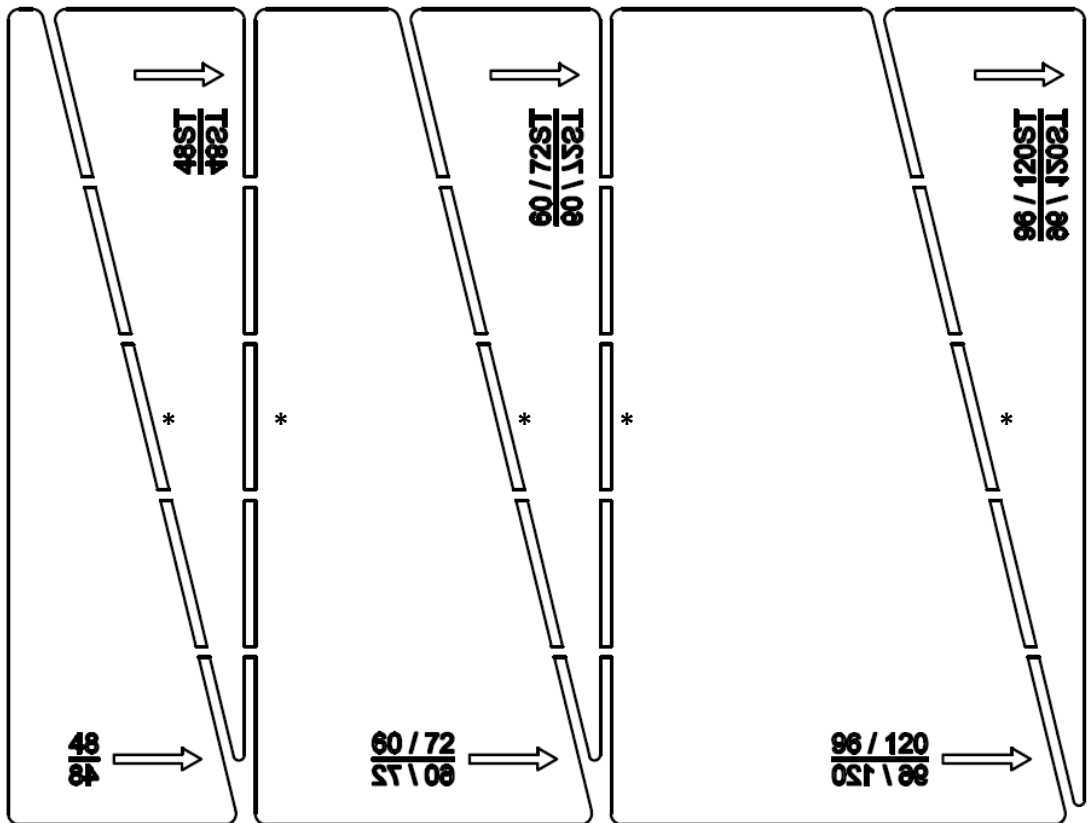

FIGURE 15

- ISFX48LB in a 60" Isokern Fireplace shown ABOVE.

FIGURE 16







\*PERFORATED SECTIONS  
FOR ADJUSTABLE LENGTHS  
NOTE: THE ARROWS  
INDICATE ISOKERN FIREBOX  
MODEL.. NOT TO BE  
CONFUSED WITH BURNER  
MODEL



The end cap is designed to provide an elevated platform in the cavity for the media. They are perforated at the indicated arrows to accommodate various length combinations with Isokern Fireboxes. Remove a section by bending back and forth at the perforated segment labeled with arrows per firebox model in **Figure 16**.



## Media Options

Component	Part#	Description
	RFG-10-VB	1/2" REFLECTIVE VESPER BLACK FIRE GLASS (10 LB JAR)
	RFG-10-PB	1/2" REFLECTIVE POSEIDON BLUE FIRE GLASS (10 LB JAR)
	RFG-10-TC	1/2" REFLECTIVE TERRA COPPER FIRE GLASS (10 LB JAR)
	RFG-10-KD	1/2" REFLECTIVE KRYSTALLO DIAMOND FIRE GLASS (10 LB JAR)
	RFG-10-AD	1/2" REFLECTIVE AMBER DIAMOND FIRE GLASS (10 LB JAR)
	EC-BLRK	BLACK LAVA PEBBLE

Vesper Black glass media will be included with the Isoflames XL Linear Burner. The following designated amount will be included for each size.

- ISFXLB24: 2 (10lb) Jars
- ISFXLB36: 3 (10lb) Jars
- ISFXLB48: 4 (10lb) Jars
- ISFXLB60: 5 (10lb) Jars
- ISFXLB72: 7 (10lb) Jars
- ISFXLB96: 9 (10lb) Jars

Additional media colors/options are available, sold separately.

## Troubleshooting

Earthcore Industries Technical Support: 1-800-642-2920

KW at (817)-393-4029

Issue	Probable Cause	Possible Solution
No spark on pilot	No power	<ul style="list-style-type: none"> <li>• Verify power is ON</li> <li>• Check wiring on ignition module , Meridian Control Panel, and gas valve are correct</li> </ul>
	Ignitor misalignment	<ul style="list-style-type: none"> <li>• Verify ignitor not contacting pilot gas hood</li> </ul>
	Loose pilot connections	<ul style="list-style-type: none"> <li>• Check pilot wiring assembly is tightly secured to ignition module</li> </ul>
Pilot won't ignite	No spark	<ul style="list-style-type: none"> <li>• See "No spark on pilot"</li> </ul>
	Air in pilot gas line	<ul style="list-style-type: none"> <li>• It may take a few minutes to purge out all the air from the pilot gas tube to ignite</li> </ul>
	No gas	<ul style="list-style-type: none"> <li>• Verify pilot gas tube is threaded sufficiently to gas valve</li> <li>• Verify all gas connections going to and from gas valve are tight</li> <li>• Verify main gas-shutoff valve is in ON position</li> </ul>
Pilot won't stay ignited	Flame sensor obstruction	<ul style="list-style-type: none"> <li>• Remove any obstruction near pilot igniter and flame sensor</li> </ul>
	Loose pilot connections	<ul style="list-style-type: none"> <li>• Check pilot wiring assembly is tightly secured to ignition module</li> </ul>
	Low gas pressure	<ul style="list-style-type: none"> <li>• Verify adequate gas supply pressure</li> </ul>
Remote won't work/ unresponsive	Range	<ul style="list-style-type: none"> <li>• Remote is too far from receiver</li> </ul>
	Batteries need replacement	<ul style="list-style-type: none"> <li>• Replace batteries on remote transmitter</li> </ul>
	Program remote to receiver	<ul style="list-style-type: none"> <li>• Sync remote transmitter to ignition module; Page 60</li> </ul>
Main burner won't ignite	Pilot won't ignite	<ul style="list-style-type: none"> <li>• See "Pilot won't ignite"</li> </ul>
	Pilot flame won't stay ignited	<ul style="list-style-type: none"> <li>• See "Pilot won't stay ignited"</li> </ul>
	Loose burner segments	<ul style="list-style-type: none"> <li>• Verify burner segments are tight and secure</li> </ul>
	Orifice blockage	<ul style="list-style-type: none"> <li>• Remove burner top pan tray and visually inspect orifice gas block</li> </ul>
	Defective valve/ignition module	<ul style="list-style-type: none"> <li>• Replace gas valve or ignition module</li> </ul>



## Warranty & Disclaimer

### Isoflames XL Linear Burner

ISOKERN offers a Lifetime Warranty for all Isokern components, to be free from defects in materials that negatively affect system performance from the date of purchase, subject to the terms and conditions of this limited warranty.

This warranty covers only the above stated components. THIS WARRANTY DOES NOT COVER DRAFTING, SMOKING OR PUFFING OF THE FIREPLACE SYSTEM. Factors beyond the manufacturer's control affect fireplace drafting, smoking, and puffing, and ISOKERN cannot guarantee these aspects of performance.

#### EXCLUSIONS AND LIMITATIONS

This Lifetime Warranty applies only if the Product is installed in the United States and Canada and only if operated and maintained in accordance with the printed instructions accompanying the Product and in compliance with all applicable installation and building codes and good trade practices. This warranty is non-transferable and extends to the original owner only. The following do not carry the Lifetime Warranty but are warranted as follows:

Burner – Repair or replacement for five years from the date of installation

Gas components & electrical components – Repair or replacement for one year from the date of installation

Batteries – Replacement for 90 days from the date of installation

Logs – Replacement for five years from the date of installation against thermal breakage only Remote controls – Repair or replacement for one year from the date of installation

Parts not otherwise listed carry a 90 day warranty from the date of installation.

If a component is found to be defective under the terms of this warranty the party to whom this warranty is extended shall, notify ISOKERN, 6899 Phillips Industrial Blvd, Jacksonville, Florida 32256, in writing, by registered mail, within thirty (30) days following the discovery of the defect within the lifetime warranty period. The notice shall contain (1) the date of purchase; (2) place of purchase; (3) address of installation; (4) name, address and phone number of the owner; and (5) a brief description of the defect.

ISOKERN, or any division thereof, is not responsible for any labor costs or indirect costs incurred for the replacement of defective components.

ISOKERN is not responsible for misuse or mishandling of components. Nothing in this warranty makes ISOKERN, or any division thereof, liable in any respect for any injury or damage to the building or structure in which the fireplace or chimney system has been installed or to persons or property therein arising out of the use, misuse, or installation of properly manufactured ISOKERN product.

ISOKERN, OR ANY DIVISION THEREOF, SHALL NOT BE HELD LIABLE FOR ANY INCIDENTAL OR CONSEQUENTIAL DAMAGES OR EXPENSES ARISING OUT OF THE USE OF THE FIREPLACES OR CHIMNEY SYSTEMS. ALL SUCH DAMAGES AND EXPENSES ARE HEREBY EXCLUDED.

This warranty is null and void when the fireplace or chimney systems are not installed pursuant to the installation instructions provided by ISOKERN or local building codes have not been followed completely.

This warranty applies only to those fireplace and chimney systems installed in the continental United States and Canada. If any part of this warranty is found to be unenforceable, the remaining parts shall remain in force and effect.

ISOKERN HEREBY DISCLAIMS ALL GUARANTEES AND WARRANTIES, EXPRESS OR IMPLIED, BEYOND THE WARRANTIES SET FORTH HEREIN.

**earthcore**<sup>®</sup>